

X R 7
W A S H

ENG

X R 7
W A S H

X R 7
W A S H

X R 7
W A S H



D.T.S.
Show division



Le informazioni contenute in questo documento sono state attentamente redatte e controllate. Tuttavia non è assunta alcuna responsabilità per eventuali inesattezze. Tutti i diritti sono riservati e questo documento non può essere copiato, fotocopiato, riprodotto per intero o in parte senza previo consenso scritto della DTS .

DTS si riserva il diritto di apportare senza preavviso cambiamenti e modifiche estetiche , funzionali o di design a ciascun proprio prodotto. DTS non assume alcuna responsabilità sull'uso o sull'applicazione dei prodotti o dei circuiti descritti.

The information contained in this publication has been carefully prepared and checked. However, no responsibility will be taken for any errors. All rights are reserved and this document cannot be copied, photocopied or reproduced, in part or completely, without prior written consent from DTS. DTS reserves the right to make any aesthetic, functional or design modifications to any of its products without prior notice. DTS assumes no responsibility for the use or application of the products or circuits described herein.

Les informations contenues dans le présent manuel ont été rédigées et contrôlées avec le plus grand soin. Nous déclinons toutefois toute responsabilité en cas d'éventuelles inexactitudes. Tous droits réservés. Ce document ne peut être copié, photocopié ou reproduit, dans sa totalité ou partiellement, sans le consentement préalable de DTS.

DTS se réserve le droit d'apporter toutes modifications et améliorations esthétiques, fonctionnelles ou de design, sans préavis, à chacun de ses produits. DTS décline toute responsabilité sur l'utilisation ou sur l'application des produits ou des circuits décrits.

Las informaciones contenidas en este documento han sido cuidadosamente redactadas y controladas. Con todo, no se asume ninguna responsabilidad por eventuales inexactitudes. Todos los derechos han sido reservados y este documento no puede ser copiado, fotocopiado o reproducido, total o parcialmente, sin previa autorización escrita de DTS.

DTS se reserva el derecho a aportar sin previo aviso cambios y modificaciones de carácter estético, funcional o de diseño a cada producto suyo. DTS no se asume responsabilidad de ningún tipo sobre la utilización o sobre la aplicación de los productos o de los circuitos descritos.

INDEX:

1- Technical Features	PG 1
2- Important Safety Information	PG 2
2.1 Fire Prevention	
2.2 Prevention Of Electric Shock	
2.3 Protection Against Ultraviolet Radiation	
2.4 Safety	
2.5 Level Of Protection Against The Penetration Of Solid And Liquid Matter	
3- Mounting The Lamp	PG 3
3.1 Lamp Alignment	
4- Voltage And Frequency	PG 4
5- Installation	PG 4
5.1 Safety Chain	
5.2 Protection Against Liquids	
5.3 Movement	
5.4 Risk Of Fire	
5.5 Forced Ventilation	
5.6 Ambient Temperature	
6- Mains Connection	PG 5
6.1 Protection	
7- Dmx Signal Connection	PG 6
8- Dmx Addresses	PG 7
8.1 Changing The Dmx Addresses	
9- Display Functions	PG 8
9.1 Automatic Operation	
9.2 Pan & Tilt Speed (Spee) (Default: 2)	
9.3 Fan Speed (Fans) (Default: 6)	
10- Error Messages	PG 11
11- Hidden Menu	PG 12
12- Opening Up The Projector Housing	PG 13
13- Periodic Cleaning & Controls	PG 14
13.1 Lenses And Raylight Reflectors	
13.4 Fans And Air Passages	
13.3 Lamp	
13.4 Mechanical Parts	
13.5 Electrical Components	
13.6 Fuse Replacement	
13.7 Warning!	
16- Wiring Connections	PG 15
14- Dmx Signal Function	PG 17

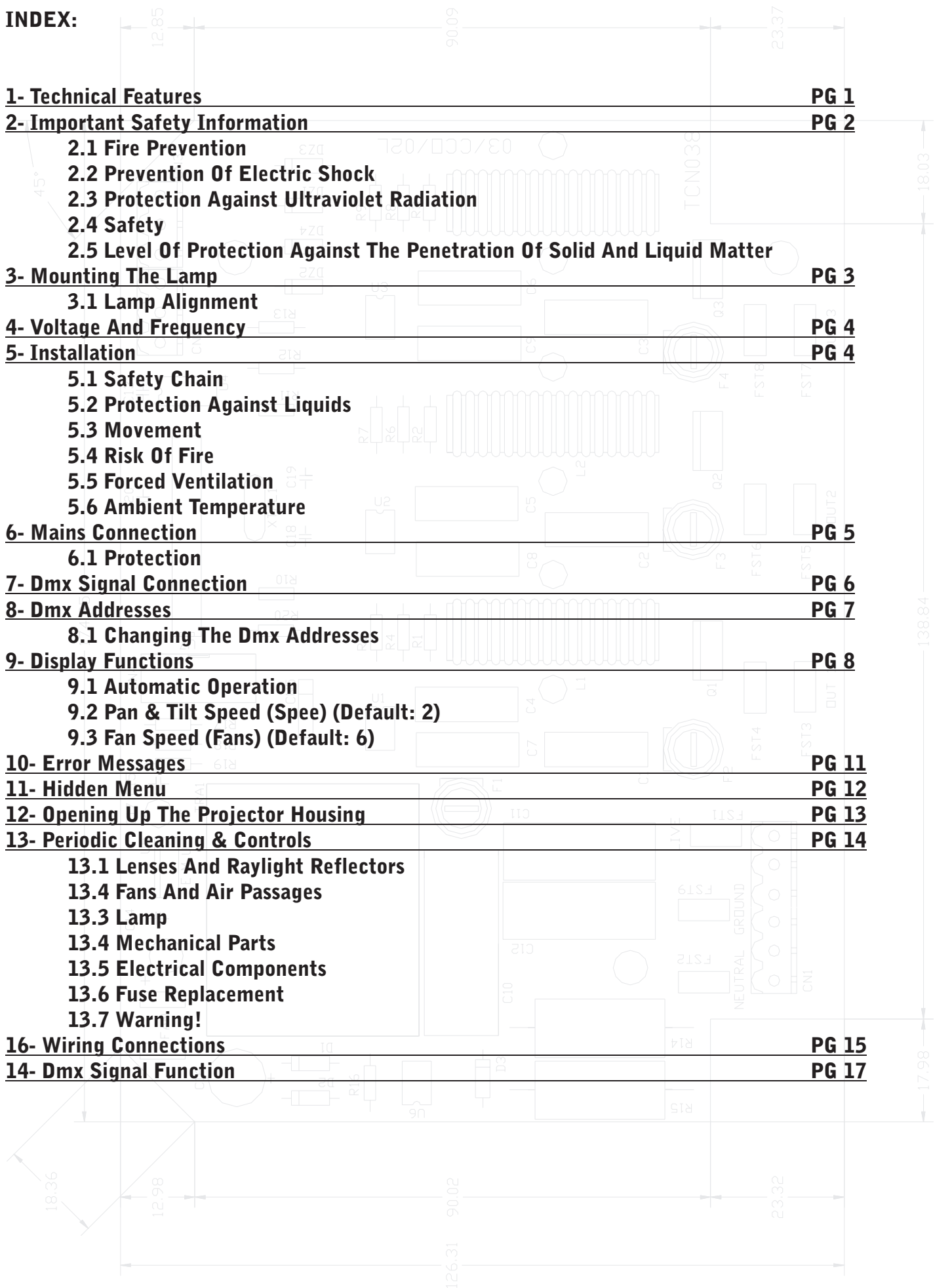

2- IMPORTANT SAFETY INFORMATION

2.1 Fire prevention:

- 1. XR7 Wash uses a Philips 575 MSR/2 or MSD 575/2 lamp. The use of any alternative lamp is not recommended and will null and void the fixture's warranty.**
- 2. Never locate the fixture on any flammable surface.**
- 3. Minimum distance from flammable materials: 0.5 m.**
- 4. Minimum distance from the closest illuminable surface: 2 m.**
- 5. Replace any blown or damaged fuses only with those of identical value. Refer to the wiring diagram if there is any doubt.**
- 6. Connect the projector to mains power via a thermal magnetic circuit breaker.**

2.2 Prevention of electric shock:

- 1. High voltage is present inside the unit. Isolate the projector from the mains supply prior to performing any function which involves touching the inside of the unit, including lamp replacement.**
- 2. The level of technology inherent in the Xr7 Wash requires the assistance of specialised personnel for all servicing. Refer all work to your authorised DTS service centre.**
- 3. A good earth connection is essential for proper functioning of the projector. Never connect the unit without proper earth connection.**
- 4. The fixture should never be located in a position exposed to rain or in areas of extreme humidity. A steady supply of circulating air is essential.**

2.3 Protection against ultraviolet radiation:

- 1. Never turn the lamp on if any of the lenses, filters or the carbon fibre housing is damaged. Their respective shielding functions will only operate efficiently if they are in perfect working order.**
- 2. Never look directly into the lamp when it is on.**

2.4 Safety:

- 1. The projector should always be installed with bolts, clamps and other fixtures that are capable of supporting the weight of the unit.**
 - 2. Always use a second safety chain of a suitable rating to sustain the weight of the unit in case of the failure of the main fixing point.**
 - 3. The external surface of the unit, at various points, may exceed 150°C. Never handle the unit until at least 10 minutes have elapsed since the lamp was turned off.**
 - 4. Always replace the lamp if any physical damage is evident.**
 - 5. Never install the fixture in an enclosed area lacking sufficient air flow. The ambient temperature should not exceed 35°C.**
 - 6. A hot lamp may explode, so always wait for at least 10 minutes to elapse after the unit has been turned off prior to attempting to replace the lamp.**
- Always wear suitable hand protection when handling the lamp.**

2.5 Level of protection against the penetration of solid and liquid matter

- 1) The projector is classified as an ordinary appliance and its level of protection against the penetration of solid and liquid matter is IP 20. XR7 Wash uses 575W Philips 575 MSR/2 lamps with GX 9.5 base.**

The temperature inside the projector can reach 250° C after just 5 minutes, but it can

get as high as 350° C. Always check that the lamp is cold before attempting to remove it. In any case, only open the appliance 10 minutes after it has been turned off.

3- MOUNTING THE LAMPS

Warning: turn power off before opening the appliance.

Philips 575 MSR/2
Power 575W
Luminous flux 49,000 lm
Colour temperature 5600°K
Lampbase GX9,5
Rated life 1,000 hours

1) Using a Philips screwdriver, remove the 3 screws (X,Y, Z) (photo 1, black screws) which hold the lampholder in place and are located at the rear of the projector head.



Photo 1



Photo 2



Photo 3



Photo 4

2) Remove the lampholder unit. Locate the lampholder (photo 2).

3) Insert the lamp (photo 3).

The lamp used is manufactured from quartz glass and should be handled with care. Always adhere to the instructions supplied in the lamp's packaging. Never touch the glass directly but use the tissue provided in the lamp's packaging. The GX 9.5 lampbase is symmetrical.

DO NOT USE UNDUE FORCE ON THE GLASS. In case of difficulty, re-read the instructions and repeat the procedure.

4) Replace the lamp assembly (photo 4) and replace and tighten the screws (X,Y,Z), which were previously removed (photo 1).

3.1 Lamp alignment

Warning: we recommend that the lamp be realigned in the optical train of the unit to avoid overheating of the dichroic filters and other components inside the unit. (Photo 5).



Photo 5

Alignment is carried out using the 3 adjusters A, B and C (white screws). During this operation you must bring the hot-spot to the centre of the beam and flatten it as much as possible.

4- VOLTAGE AND FREQUENCY

The projector can operate at 230V voltage, at 50 or 60 Hz. D.T.S. default presets a voltage of 230V at a frequency of 50Hz (barring specific requests).

5- Installation

XR7 may be either floor or ceiling mounted.

For floor mounting installations, the XR7 is supplied with four rubber mounting feet (B) on the base.

For ceiling mounted installations, we suggest the use of appropriate clamps or fixings to attach the fixture to the mounting surface.

The supporting structure from which the unit is hung should be capable of bearing the weight of the unit, as should any clamps used to hang it. The structure should also be sufficiently rigid so as not to move or shake whilst the XR7 moves during its operation. Four quarter turn fast locks placed on the base of the units allow for the fixing of brackets that can then be fixed on to the rails with the use of C clamps or Aliscaf type clamps.

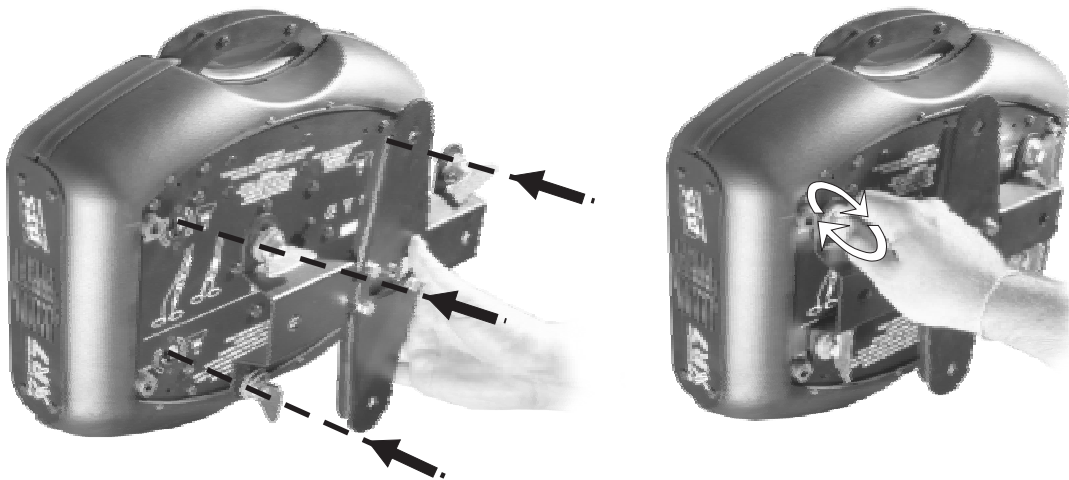

5.1 Safety chain

We recommend the use of a safety cable or chain connected to the Xr7 Wash and to the suspension truss in order to avoid the fixture accidentally falling should the main fixing point fail. Make sure that the iron cable or chain can bear the weight of the entire unit. You may attach the safety chain to the two holes (A) located on the base of the fixture, as shown in the diagram below.

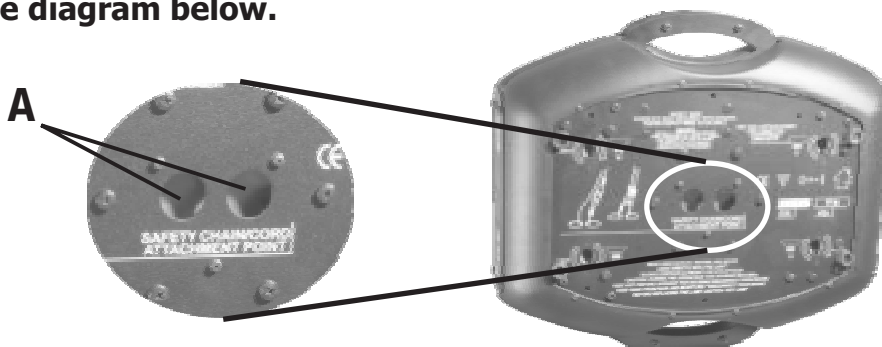

5.2 Protection against liquids:

The projector contains electric and electronic components which should under no circumstances come into contact with oil, water or any other liquid. The proper working of the unit would be compromised should this occur.

5.3 Movement:

The projector has a maximum movement of 540° in the base and 320° in the yoke. **DO NOT** place any obstructions in the path of the projector's movement.

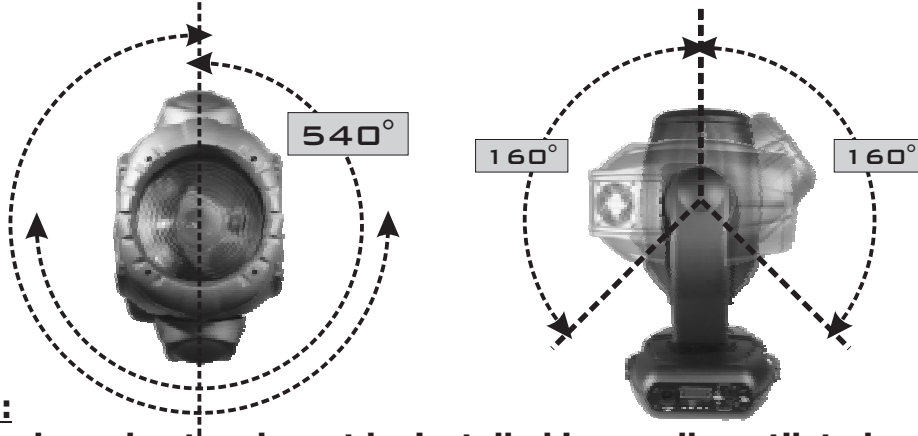
**5.4 Risk of fire:**

Each fixture produces heat and must be installed in a well-ventilated position. The minimum recommended distance from flammable material is 0.5m. Minimum distance from the object being illuminated is 2 m.

5.5 Forced ventilation

You will note, on inspection, that the fixture features various air inlets and cooling fans located on both the base and head of the fixture. These should, under no circumstances, be blocked or obstructed whilst the projector is in operation.

Doing so could cause the fixture to seriously overheat thereby compromising its proper operation.

5.6 Ambient temperature

The projector should never be installed in places that lack a constant flow of air. The ambient temperature should not exceed 35°C.

6- MAINS CONNECTION

Xr7 Wash operates at voltage 230V at 50 or 60Hz. Prior to connecting the unit to your mains supply, ensure that the model in your possession correctly matches the mains supply available. For connection purposes, ensure that your plug is of a suitable rating of 8 amps at 230V.

Strict adherence to regulatory norms is strongly recommended.



230V at 50 or 60Hz

Protection

The use of a thermal magnetic circuit breaker is recommended for each Xr7 Wash. A good earth connection is essential for the correct operation of the projector.

7- DMX SIGNAL CONNECTION

The unit operates using a digital DMX 512 (1990) signal. Connection between the control box and the projector or between projectors must be carried out using a two pair screened $\varnothing 0.5$ mm cable and a CANNON XLR 5 or 3 pole connector.

Ensure that all conductors are isolated from one another and from the metal plug housing.

The plug housing must be isolated. Connect the control box signal to the DMX IN projector plug and connect it to the next projector by connecting the DMX OUT plug on the first projector to the DMX IN plug on the second.

In this way, all the projectors are cascade connected.

NB. If the display showing the DMX address flashes, then one of the following errors has occurred:

- DMX signal not present
- DMX address not valid
- DMX reception problem

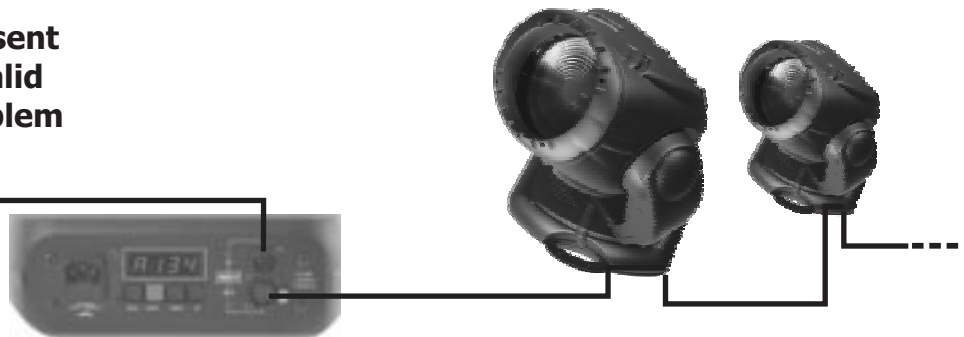
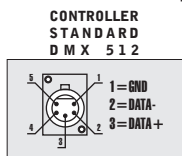

TERMINAL DMX SIGNALS:

Install when the signal wire has to be put in long distances or where there are electrical disturbances for example in a disco, concert, theater etc we advise to use a dmx terminal. the dmx terminal or even more a canon xrl-5 connected with a resistance to 120 ohm between 2 and 3 the resistance is put in the plug of the dmx of the last device that has been linked as shown following.

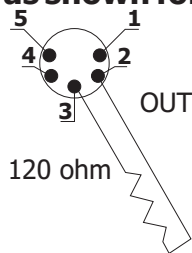

ATTACHMENT OF THE TERMINAL DMX INSTALL A RESISTANCE OF 120(OHM) BETWEEN 2 AND 3 IN THE PLUG XRL AND INSERT IN THE DIGITAL PLUG OUT OF THE LAST DEVICE OF THE ROW

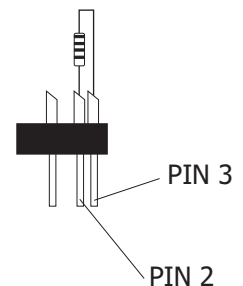

The standard configuration of the Xr7 Wash is with XLR 5 pole connection.

To convert to an XLR 3 pole configuration proceed as follows:

- 1) Unscrew the external cover (photo 1).
- 2) Unscrew the screws that fix the connectors to the panel (photo 2).
- 3) Rotate the electronic card by 180° (photo 3).
- 4) Position the 3 pole connectors in the special holes and close.



Photo 1



Photo 2



Photo 3

8-DMX ADDRESSES

Xr7 Wash can be used in three different modes: 8, 10,14 or 16 DMX channels.

If you want to use a DMX controller with 8 channels, select the 8 CH mode from the MODE menu and set the following addresses:

Projector 1 A001
Projector 2 A009
Projector 3 A017
..... A....
projector 6 A041

If you want to select the next projector, just add "8"

If you want to use a DMX controller with 10 channels, select the 10 CH mode from the MODE menu and set the following addresses:

Projector 1 A001
Projector 2 A011
Projector 3 A021
..... A....
Projector 6 A051

If you want to select the next projector, just add "10"

If you want to use a DMX controller with 14 channels, select the 14 CH mode from the MODE menu and set the following addresses:

Projector 1 A001
Projector 2 A015
Projector 3 A029
..... A....
Projector 6 A071

If you want to select the next projector, just add "14"

If you want to use a DMX controller with 16 channels, select the 16 CH mode from the MODE menu and set the following addresses:

Projector 1 A001
Projector 2 A017
Projector 3 A033
..... A....
Projector 6 A081

If you want to select the next projector, just add "16"

The address that has to be set on each projector generally depends on the number of channels that the DMX mixer allots it.

If you have a 12 channel controller, set your Xr7 Wash to 10 CH MODE. The first projector will have an A001 address and if you want to select the next projector, then you have to add 12.

8.1 Changing the DMX address

- 1) Press the UP-DOWN key until you reach the required DMX number. The numbers on the display will start to flash (but the new DMX address hasn't yet been set).
- 2) Press ENTER to confirm your selection. The numbers on the display will stop flashing and the projector is now controlled by the new 512 DMX number.

WARNING: if you press the UP-DOWN keys together the channels are calculated more quickly and you get a faster selection.

9-DISPLAY FUNCTIONS

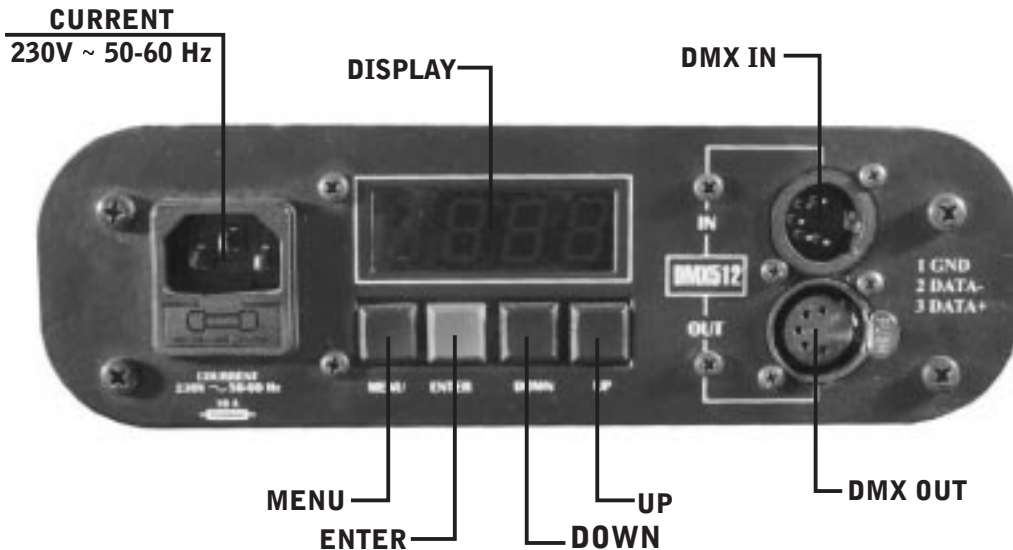

The Xr7 Wash display panel shows all the functions available. Using these functions, it is possible to change some of the parameters and to add some functions. Changing the DTS setting can vary the functions of the appliance so that it does not respond to the DMX 512 used to control it. Carefully follow the instructions below before carrying out any variations or selections.

NOTE: the symbol  shows which key has to be pushed to obtain the function desired.

  **ADD 1** —   **Pd ir** —   **CU** **CLOCKWISE**

PAN MOVEMENT INVERSION
To reverse horizontal direction of the beam from left to right and vice versa on DMX level variation.

  **CCU** **ANTI-CLOCKWISE**

  **td ir** —   **CU** **CLOCKWISE**

TILT MOVEMENT INVERSION
To reverse vertical direction of the beam from the bottom upwards and vice versa on DMX level variation

  **CCU** **ANTI-CLOCKWISE**

  **d 15P** —   **AA** **UNIT PLACED ON GROUND**

REVERSE DISPLAY
Reverses display's reading depending on the mounting position (on the ground or suspended).

  **BB** **UNIT PLACED OVERHEAD**



MODE



16.16

16 CHANNEL Pan/Tilt 16 bit



14.8

14 CHANNEL Pan/Tilt 8 bit



10.16

10 CHANNEL Pan/Tilt 16 bit



10.8

10 CHANNEL Pan/Tilt 8 bit



8.8

8 CHANNEL Pan/Tilt 8 bit

DMX MODE
To select DMX mode : 8-10-14-16 channels



TEST



TEST

TEST MODE
Device operation test.



AUTO



SURE



CAN 1



CAN 2



CAN 3



CAN.P



ESC



SPEED



FOCU



SPEED

AUTOMATIC MODE
Automatic demo game without DMX controller



RESET



RESET

RESET
To reset all motors function



DFSE



SURE



DEFAULT
To restore default setting (set by DTS)



SOFT



14.11

SOFTWARE VERSION
Electronic card software version.

Pcb 8 motors . Pcb PAN&TILT



FANS



1



FAN CONTROL
To control the fan speed .



12



TIME



LAMP



TIMER
Visualization of lamp life (reset possible) and total time unit's working (reset not possible)



Unit



RESET



SPEED



1



SPEED
To change the maximum speed of PAN and TILT movement



4



LAMP



DMX



ON / OFF VIA DMX (default)

LAMP ON/OFF lamp



on



FORCED ON



off



FORCED OFF



REC



16CH



r.017

REC
Record mode



10CH



SLAV



SURE



SLU

Slave
Slave mode as run by GAM.P, Synchronised with master

ESC

Automatic operation (auto)

XR7 can work in automatic mode without a DMX controller.

First of all connect the projectors with a DMX cable (picture below).

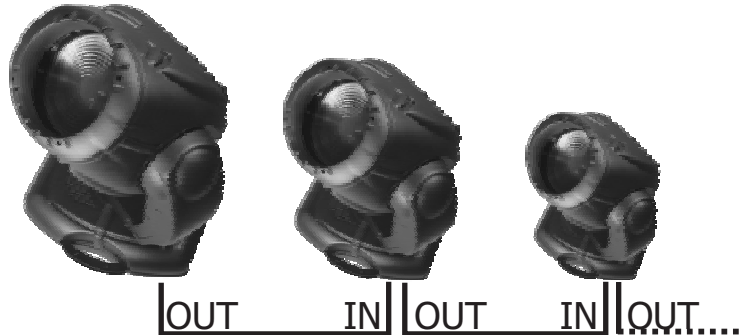
MASTER

To activate Auto mode on the first unit, use the menu to run through the different modes until AUTO appears on the display, at this point press enter.

Now it is possible to choose between the different pre-programmed games (GAME 1-2-3) or Game P which is user programmable through REC mode. To confirm game activation press ENTER on the chosen GAME.

GAME 1-2-3

The first unit that will work as a Master should be placed in Automatic mode (AUTO), the other projectors have to be placed in 16 channels DMX mode (MODE 16CH) and the DMX address should be set at A001. Once a game is chosen and set it is possible to select the speed of the game (SPEE) and the gobo focus (FOCU).

GAME P

The first unit that will function as a Master must be put in (AUTO) mode, the other projectors have to be put in slave mode (selectable through the menu). In this way all units will be synchronised with the master, the projectors need not be of the same model.

On the master unit it is possible to vary the speed of the GAME P (SPEE)

NB: It is possible to run GAME P on the other units even though these do not have GAME P programmed. You can do this by setting the units to the same mode as the master is set before programming GAME P (10CH or 16CH DMX) and selecting A001 as the DMX address.

REC MODE

It is possible to programme your own game on the XR7 that will then run in AUTO mode (GAME P). Each unit can have its own programmed game.

In REC mode each projector must be set to the same mode (10CH or 16CH DMX).

For the programming of GAME P besides the channels necessary to control the unit a further 3 DMX channels are needed. So that in REC mode if the 10CH mode is selected you will need 13 channels for the programme to work correctly whereas 16CH mode would occupy 19 channels.

Connect the unit to a DMX mixer/controller, every unit should be set to its own Address (See the paragraph on DMX addresses). The projectors can also be different of models: XR7 spot/wash and XR 250 spot/wash. When you are in REC mode R.001 appears on the display (DMX address).

The three new DMX channels are:

-Scene channel

-From 0-255 are displayed the programmable scenes (max 16 scenes M.001 M016)

-View channel:

-From 1-19 the unit runs the scene that has been saved in the units memory and it is possible to play through the other scenes using the scene channel.

-From 20-235 the unit runs the configuration given by the received input DMX values. With the channel scene it is possible to pass from one scene to the next while with REC it is possible to record the selected scene.

-From 236-255 the unit runs the configuration given by the received DMX values from the projector in that moment. It is possible to select a scene and then close the GAME P with the REC channel.

-Recording channel (REC)

Records the set scene with a variable between 0 and 255 (the display flashes indicating that the scene has been recorded).

It is advised that you keep the REC channel set to 0 and to run through the 255 only once you have decided to save the scene. If GAME P is not closed, by indicating the last scene, in playback mode all 16 scenes will be played through even if not programmed.

9.2 Pan & Tilt speed (SPEE) (default: 2)

You can set the PAN and TILT engines at high speed on your Xr7 Wash.

Press menu until you see SPEE.

Press ENTER and select a speed with UP-DOWN (there are 4 speeds). Confirm by pressing ENTER.

When you use speed 4 (the highest) PAN and TILT speed is very high and your projector may lose its path. In this case, the encoder corrects the position.

9.3 Fan speed (FANS)(default: 6)













Fan speed regulation makes it possible to reduce fan noise. However, the ambient temperature must be less than 35° C.

WARNING!

If the ambient temperature is too high, two thermal sensors will turn the lamp off.

In this case, you must increase the fan speed to ensure correct cooling of your XR7.

10- ERROR MESSAGES:

	————	ERROR POSITIONING OF COLOUR WHEEL		————	ERROR ENCODER PAN
	————	ERROR POSITIONING OF BEAM SHAPE EFFECTS		————	ERROR ENCODER TILT
	————	ERROR POSITIONING OF ZOOM		————	ERROR ADDRESS DMX
	————	ERROR ALIGNMENT SENSORS OF ZOOM LENS		————	ERROR LOADING EPROM DATA
	————	ERROR INPUT IN AUTO MODE		————	ERROR COLOUR SENSOR CIRCUIT/ZOOM 1
	————	ERROR INTERNAL COMMUNICATION		————	ERROR COLOUR SENSOR CIRCUIT/ZOOM 2
	————	ERROR SYNCHRONIZED FREQUENCY MEASURE (SYNCHRONISM FOR LAMP ON)			

11- HIDDEN MENU

For technical personnel only.

To operate this menu:

-Connect the projector to the DMX controller (DMX SIGNAL MUST BE CORRECTLY RECEIVED)

-Reset the Xr7 Wash (reset from the display projector, not from the DMX controller!).

-While reset is working, press the MENU and ENTER keys at the same time.

CAL Electronic calibration of the motors.

RESN Reset EEPROM (Reset all settings. ATTENTION: by pressing this key you must repeat all previous calibrations)

ESC Exit from hidden menu.

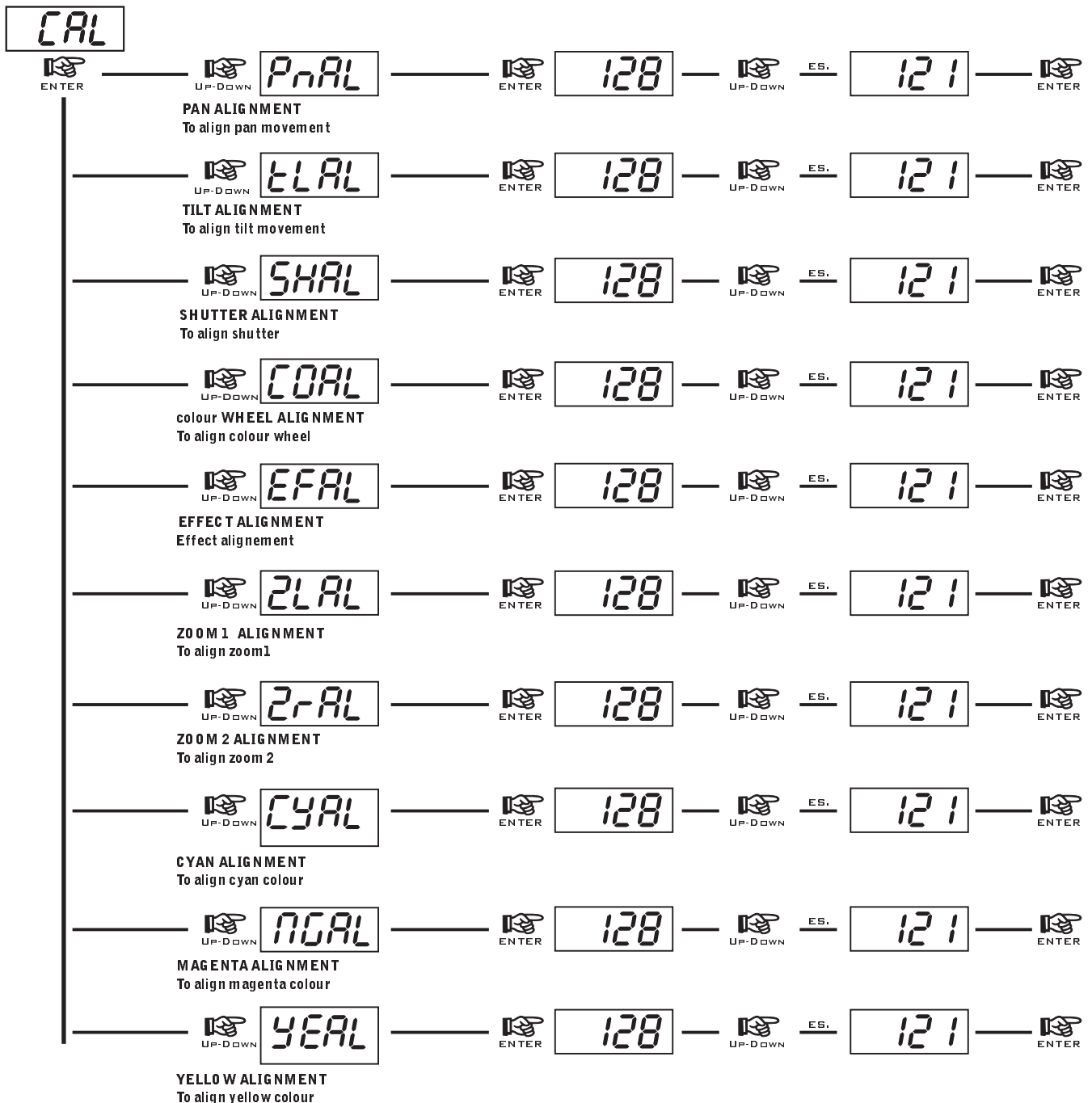

12- OPENING UP THE PROJECTOR HOUSING

It is possible to inspect the inside of the projector by removing the cover as indicated below.

WARNING!

REMOVE MAINS POWER PRIOR TO ACCESSING THE PROJECTOR'S INTERNAL COMPONENTS.

- 1) Loosen the screws which fix the upper and lower covers (photo 1) and unscrew the side covers (photo 2).
- 2) Once unscrewed, simply lift the covers to access the internal components (photo 3).



Photo 1



Photo 2



Photo 3

13- PERIODIC CLEANING E CONTROLS

13.1 Lenses and raylight reflector

Even a fine layer of dust can reduce the luminous output substantially. Regularly clean all lenses and the reflector using a soft cotton cloth, dampened with a specialist lens cleaning solution.

13.2 Fans and air passages

The fans and air passages must be cleaned approximately every 6 weeks. This periodic cleaning will depend of course, on the conditions in which the projector is operating. Suitable instruments for performing this type of maintenance are a brush and a common vacuum cleaner or an air compressor. If necessary, clean the fans and air passages more frequently.

13.3 Lamp

The lamp should be replaced if there is any visible damage or deformation due to heat. This will help to avoid the danger of the lamp exploding.

13.4 Mechanical parts

Periodically check all mechanical parts gears, guides, belts, etc. For wear and tear, replacing them if necessary. Periodically check the lubrication of all components, particularly the parts subject to high temperatures. If necessary, lubricate with suitable lubricant, available from your D.T.S. distributor. Check the tension of the belts and adjust if necessary.

13.5 Electrical components

Check all electrical components for correct earthing and proper attachment of all connectors, refastening if necessary.

13.6 Fuse replacement

Locate the fuse, which protects the lamp and electronics, in the base of the Xr7 Wash.

Using a multimeter, test the condition of the fuse, replacing it with one of equivalent type if necessary.

13.7 WARNING!

Disconnect mains power prior to removing the projector housing.

MOTOR ACTUATOR CARD

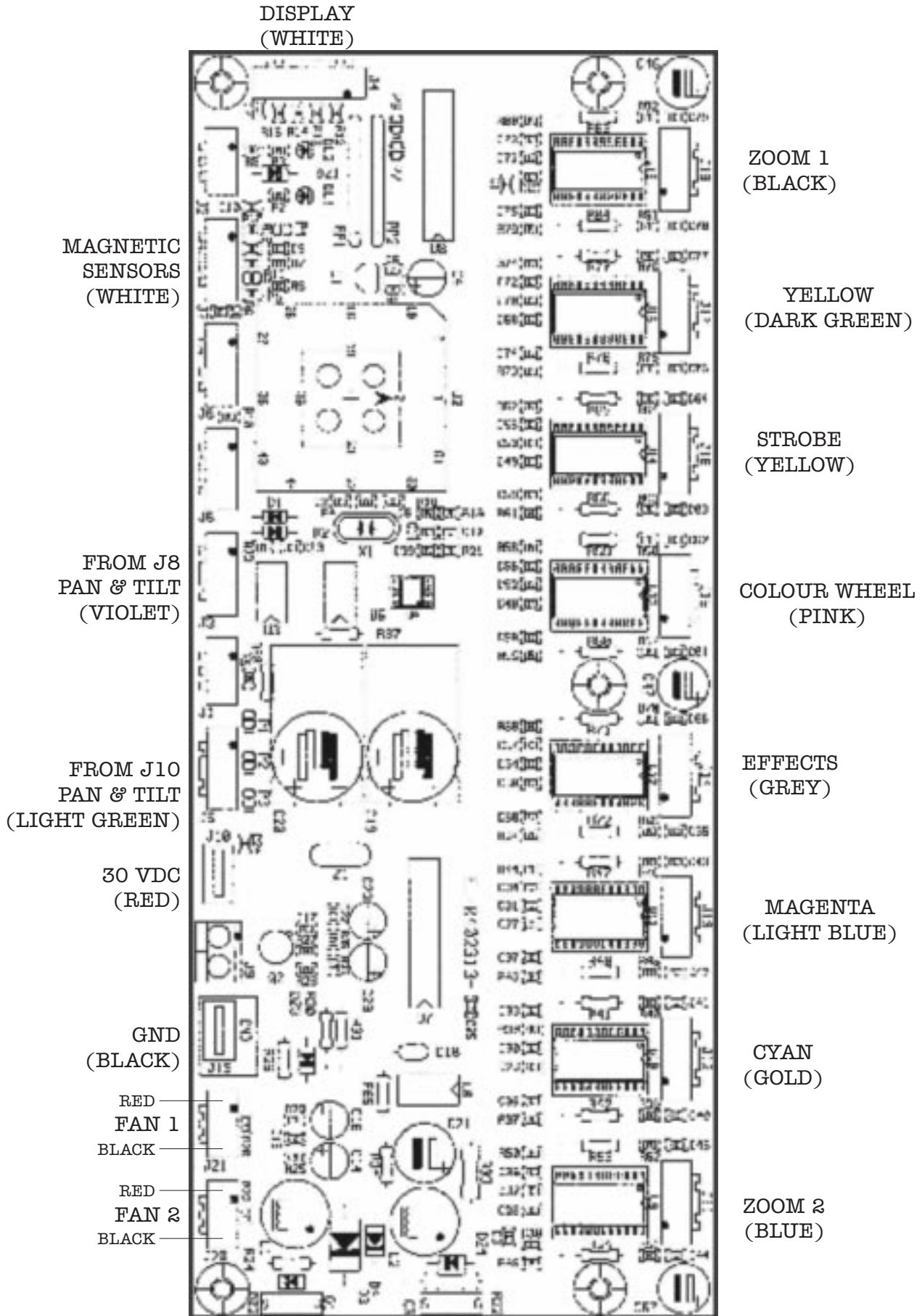

DISPLAY CARD

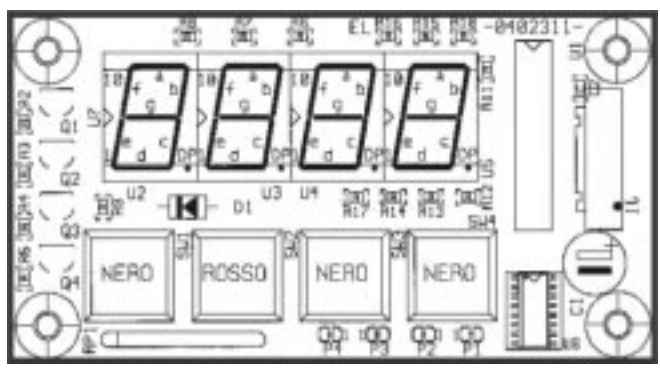

FROM J4
8 MOTOR

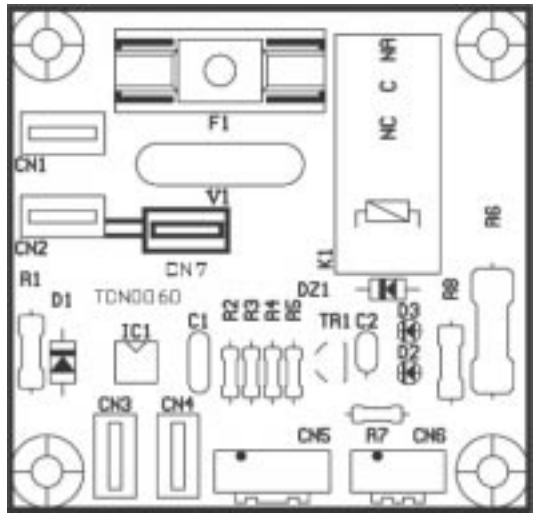

IN LAMP
OUT LAMP

ON/OFF LAMP CARD

24V-
FROM J16
PAN & TILT
CARD
FROM J7
PAN & TILT
CARD

IF THE PCB DOESN'T WORK MOVE THE CABLE
"IN LAMP" FROM Cn1 TO Cn7
TO DELETE **S_nE_r** ERROR FROM DISPLAY IN
MENU **LAMP** SELECT **off**

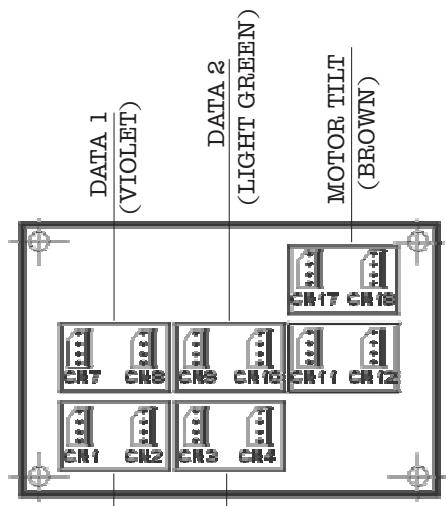

DATA 1
(VIOLET)
DATA 2
(LIGHT GREEN)
MOTOR_TILT
(BROWN)

DISPLAY 1
DISPLAY 2
(ORANGE)

CONECTOR RELAY CARD

PAN & TILT CARD

PAN (WHITE) TILT (BROWN) GND (BLACK) 30 VDC (RED) FAN (WHITE)

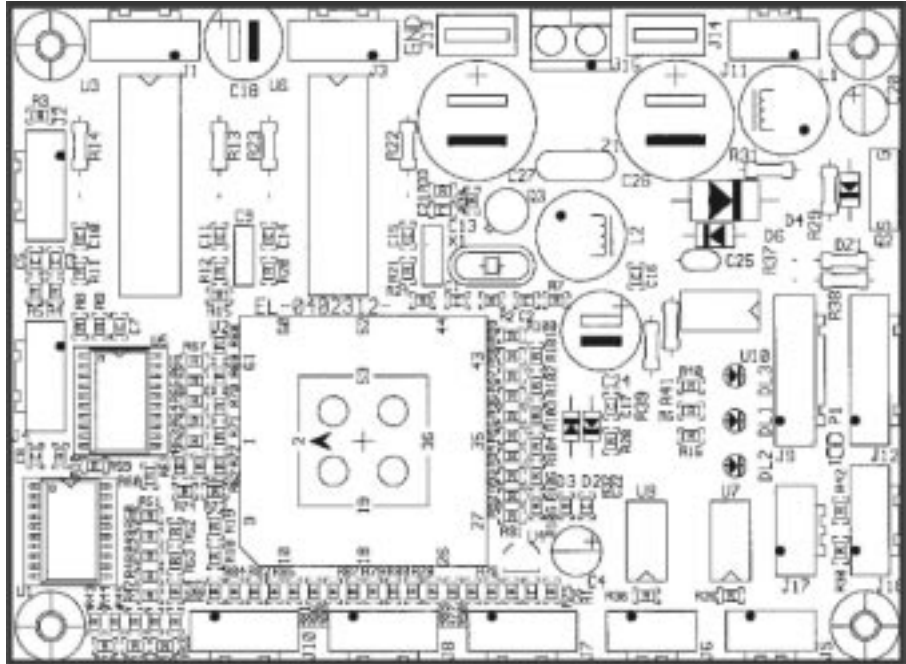

ENCODER PAN
(RED)

ENCODER TILT
(ORANGE)

FROM J5
8 MOTORI
(LIGHT GREEN)
FROM J3
8 MOTORI
(VIOLET)
DMX ING
(WHITE)

**10 CHANNEL MODE (16 bit)
DEFAULT SETTINGS**

8 CHANNEL MODE (8 bit)

- 1 DEFAULT CMY COLOUR
- 2 COLOUR
- 3 MACRO CMY/COLOUR
- 4 DIMMER/ SHUTTER
- 5 PAN msb
- 6 TILT msb
- 7 EFFECT
- 8 ZOOM
- 9 PAN lsb
- 10 TILT lsb

- 1 DEFAULT CMY COLOUR
- 2 COLOUR
- 3 MACRO CMY/COLOUR
- 4 DIMMER/ SHUTTER
- 5 PAN
- 6 TILT
- 7 EFFECT
- 8 ZOOM

DMX CHANNEL	1	Parameter: DEFAULT CMY COLOUR
-------------	----------	--------------------------------------

DMX range Value	Mid point DMX value	Move range (degrees)	Mode	Option	Function
0-35					White
36-71					Cyan
72-107					Violet
108-143					Magenta
144-179					Orange
180-215					Yellow
216-255					Green

DMX CHANNEL	2	Parameter: COLOUR
-------------	----------	--------------------------

DMX range Value	Mid point DMX value	Move range (degrees)	Mode	Option	Function
0-12					White
13-25					Colour 1 (3200° K)
26-38					Colour 2 (5600°K)
39-51					Colour 1
52-64					BiColour 1/2
65-77					Colour2
78-90					BiColour 2/3
91-103					Colour3
104-116					BiColour 3/4
117-129					Colour4
130-142					BiColour 4/5
143-155					Colour5

156-168					Bicolour 5/6
169-181					Colour6
182-197					BiColour 6/white
198-200					Right ration speed 1 max.
201-203					Right rotation speed 2
204-206					Right ration speed 3
207-209					Right ration speed 4
210-212					Right ration speed 5
213-215					Right ration speed 6
216-218					Right ration speed 7
219-221					Right ration speed 8
222-224					Right ration speed 9 min
225-228					Stop
229-231					Rotation Left speed 1 min.
232-234					Left rotation speed 2
235-237					Left rotation speed 3
238-240					Left rotation speed 4
241-243					Left rotation speed 5
244-246					Left rotation speed 6
247-249					Left rotation speed 7
250-252					Left rotation speed 8
253-255					Left rotation speed 9 max.

DMX CHANNEL	3	Parameter: MACRO CMY/COLOUR
-------------	----------	------------------------------------

DMX range Value	Mid point DMX value	Move range (degrees)	Mode	Option	Function
0-19	12				No function
20-255	38				Macro

DMX CHANNEL	4	Parameter: DIMMER / SHUTTER
-------------	----------	------------------------------------

DMX range Value	Mid point DMX value	Move range (degrees)	Mode	Option	Function
0-9	4				Black out
10-85	47				Dimmer
86-95	90				Strobe random speed
96-105	100				Strobe speed 1 min.
106-115	110				Strobe speed 2
116-125	120				Strobe speed 3
126-135	130				Strobe speed 4
136-145	140				Strobe speed 5
146-155	150				Strobe speed 6 max.
156-165	160				Flash open speed 1 min.
166-175	170				Flash open speed 2
176-185	180				Flash open speed 3
186-195	190				Flash open speed 4 max
196-205	200				Flash closed speed 1 min.

206-215	210				Flash closed speed 2
216-225	220				Flash closed speed 3
226-235	230				Flash closed speed 4 max.
236-245	240				Colour/Pan/Tilt/Macro in Blackout
246-255	250				Open

DMX CHANNEL	5	Parameter: PAN msb
-------------	---	---------------------------

DMX CHANNEL	6	Parameter: TILT msb
-------------	---	----------------------------

DMX CHANNEL	7	Parameter: EFFECT
-------------	---	--------------------------

DMX range Value	Mid point DMX value	Move range (degrees)	Mode	Option	Function
0-19	31				No effect
20-39	104				Frost
40-255	159				Beam shape

DMX CHANNEL	8	Parameter: ZOOM
-------------	---	------------------------

DMX range Value	Mid point DMX value	Move range (degrees)	Mode	Option	Function
0-255	36				Proportional

DMX CHANNEL	9	Parameter: PAN lsb
-------------	---	---------------------------

DMX CHANNEL	10	Parameter: TILT lsb
-------------	----	----------------------------

16 CHANNEL MODE (16bit)

- 1 PAN msb
- 2 PAN lsb
- 3 TILT msb
- 4 TILT lsb
- 5 SPEED MOVEMENT
- 6 DIMMER
- 7 SHUTTER
- 8 COLOUR
- 9 CYAN
- 10 MAGENTA
- 11 YELLOW
- 12 SPEED CMY / DIMMER
- 13 MACRO CMY / COLOUR
- 14 EFFECTS
- 15 ZOOM
- 16 RESET

14 CHANNEL MODE (8 bit)

- 1 PAN
- 2 TILT
- 3 SPEED MOVEMENT
- 4 DIMMER
- 5 SHUTTER
- 6 COLOUR
- 7 CYAN
- 8 MAGENTA
- 9 YELLOW
- 10 SPEED CMY / DIMMER
- 11 MACRO CMY / COLOUR
- 12 EFFECTS
- 13 ZOOM
- 14 RESET

DMX CHANNEL	1	Parameter: PAN msb
-------------	----------	---------------------------

DMX CHANNEL	2	Parameter: PAN lsb
-------------	----------	---------------------------

DMX CHANNEL	3	Parameter: TILT msb
-------------	----------	----------------------------

DMX CHANNEL	4	Parameter: TILT lsb
-------------	----------	----------------------------

DMX CHANNEL	5	Parameter: MOVEMENT SPEED
-------------	----------	----------------------------------

DMX range Value	Mid point DMX value	Move range (degrees)	Mode	Option	Function
0-10					Standard
11-25					Fast movement
26-127					Vector mode from fast to slow
128-247					Variable time reaction to DMX signal (fast to slow)
248-255					Slow reaction time to DMX signal

DMX CHANNEL	6	Parameter: DIMMER
-------------	----------	--------------------------

DMX range Value	Mid point DMX value	Move range (degrees)	Mode	Option	Function
0-8					Black-out
9-255					Proportional dimmer

DMX CHANNEL	7	Parameter: SHUTTER
-------------	---	---------------------------

DMX range Value	Mid point DMX value	Move range (degrees)	Mode	Option	Function
0-9					Black-out
10-23					Strobe random speed
24-37					Strobe speed 1 min.
38-51					Strobe speed 2
52-65					Strobe speed 3
66-79					Strobe speed 4
80-93					Strobe speed 5
94-107					Strobe speed 6 max.
108-121					Flash open speed 1 min.
122-135					Flash open speed 2
136-149					Flash open speed 3
150-163					Flash open speed 4 max.
164-177					Flash closed speed 1 min.
178-191					Flash closed speed 2
192-205					Flash closed speed 3
206-219					Flash closed speed 4 max.
220-227					Colour / Macro in black-out
228-233					Pan e Tilt in black-out
234-255					Open

DMX CHANNEL	8	Parameter: COLOUR
-------------	---	--------------------------

DMX range Value	Mid point DMX value	Move range (degrees)	Mode	Option	Function
0-12					White
13-25					Colour 1 (3200° K)
26-38					Colour 2 (5600°K)
39-51					Colour 1
52-64					BiColour 1/2
65-77					Colour2
78-90					BiColour 2/3
91-103					Colour3
104-116					BiColour 3/4
117-129					Colour4
130-142					BiColour 4/5
143-155					Colour5
156-168					Bicolour 5/6
169-181					Colour6
182-197					Bicolour 6/white
198-200					Right rotation speed 1 max.
201-203					Right rotation speed 2
204-206					Right rotation speed 3
207-209					Right rotation speed 4
210-212					Right rotation speed 5

213-215					Right rotation speed 6
216-218					Right rotation speed 7
219-221					Right rotation speed 8
222-224					Right rotation speed 9 min
225-228					Stop
229-231					Left rotation speed 1 min.
232-234					Left rotation speed 2
235-237					Left rotation speed 3
238-240					Left rotation speed 4
241-243					Left rotation speed 5
244-246					Left rotation speed 6
247-249					Left rotation speed 7
250-252					Left rotation speed 8
253-255					Left rotation speed 9 max.

DMX CHANNEL	9	Parameter: CYAN
-------------	---	------------------------

DMX range Value	Mid point DMX value	Move range (degrees)	Mode	Option	Function
0-255					Proportional colour

DMX CHANNEL	10	Parameter: MAGENTA
-------------	----	---------------------------

DMX range Value	Mid point DMX value	Move range (degrees)	Mode	Option	Function
0-255	12				Proportional colour

DMX CHANNEL	11	Parameter: YELLOW
-------------	----	--------------------------

DMX range Value	Mid point DMX value	Move range (degrees)	Mode	Option	Function
0-255					Proportional colour

DMX CHANNEL	12	Parameter: SPEED CMY / DIMMER
-------------	----	--------------------------------------

DMX range Value	Mid point DMX value	Move range (degrees)	Mode	Option	Function
0-7					No Function
8-255					Mode speed from max to min

DMX CHANNEL	13	Parameter: MACRO CMY / COLOUR
-------------	----	--------------------------------------

DMX range Value	Mid point DMX value	Move range	Mode	Option	Function
-----------------	---------------------	------------	------	--------	----------

		(degrees)			
0-19					No Function
20/255					Macro

DMX CHANNEL	14	Parameter: EFFECTS
-------------	-----------	---------------------------

DMX range Value	Mid point DMX value	Move range (degrees)	Mode	Option	Function
0-19	42				No effect
20-39	127				Frost
40/255	213				Beam Shape

DMX CHANNEL	15	Parameter: ZOOM
-------------	-----------	------------------------

DMX range Value	Mid point DMX value	Move range (degrees)	Mode	Option	Function
0-225	63				Proportional

DMX CHANNEL	16	Parameter: RESET
-------------	-----------	-------------------------

DMX range Value	Mid point DMX value	Move range (degrees)	Mode	Option	Function
0-29					No effect
30-85					Lamp OFF (actived after 3 seconds)
86 - 170					Internal motor Reset
171-235					Total Reset
236-255					Lamp ON (actived after 3 seconds)

10 CHANNEL MODE (8 bit)

- 1 CYAN
- 2 MAGENTA
- 3 YELLOW
- 4 DIMMER SHUTTER
- 5 PAN
- 6 TILT
- 7 COLOR
- 8 MACRO / CMY COLOR
- 9 EFFECTS
- 10 ZOOM

DMX CHANNEL	1	Parameter: CYAN
-------------	----------	------------------------

DMX range Value	Mid point DMX value	Move range (degrees)	Mode	Option	Function
0-255					Proportional colour

DMX CHANNEL	2	Parameter: MAGENTA
-------------	----------	---------------------------

DMX range Value	Mid point DMX value	Move range (degrees)	Mode	Option	Function
0-255					Proportional colour

DMX CHANNEL	3	Parameter: YELLOW
-------------	----------	--------------------------

DMX range Value	Mid point DMX value	Move range (degrees)	Mode	Option	Function
0-255					Proportional colour

DMX CHANNEL	4	Parameter: DIMMER / SHUTTER
-------------	----------	------------------------------------

DMX range Value	Mid point DMX value	Move range (degrees)	Mode	Option	Function
0-9					Black-out
10-85					Dimmer
86-95					Strobe random speed
96-105					Strobe speed 1 min.

106-115					Strobe speed 2
116-125					Strobe speed 3
126-135					Strobe speed 4
136-145					Strobe speed 5
146-155					Strobe speed 6 max.
156-165					Flash open speed 1 min.
166-175					Flash open speed 2
176-185					Flash open speed 3
186-195					Flash open speed 4 max.
196-205					Flash closed speed 1 min.
206-215					Flash closed speed 2
216-225					Flash closed speed 3
226-235					Flash closed speed 4 max.
236-245					Colour / Pan / Tilt / Macro in black-out
246-255					Pan e Tilt in black-out

DMX CHANNEL	5	Parameter: PAN
-------------	----------	-----------------------

DMX CHANNEL	6	Parameter: TILT
-------------	----------	------------------------

DMX CHANNEL	7	Parameter: COLOUR
-------------	----------	--------------------------

DMX range Value	Mid point DMX value	Move range (degrees)	Mode	Option	Function
0-12					White
13-25					Colour 1 (3200° K)
26-38					Colour 2 (5600°K)
39-51					Colour 3
52-64					BiColour 3/4
65-77					Colour 4
78-90					BiColour 4/5
91-103					Colour 5
104-116					BiColour 5/6
117-129					Colour 6
130-142					BiColour 6/7
143-155					Colour 7
156-168					Bicolour 7/8
169-181					Colour 8
182-197					Bicolour 8/1
198-200					Right rotation speed 1 max.
201-203					Right rotation speed 2
204-206					Right rotation speed 3
207-209					Right rotation speed 4
210-212					Right rotation speed 5
213-215					Right rotation speed 6
216-218					Right rotation speed 7
219-221					Right rotation speed 8
222-224					Right rotation speed 9 min

225-228					Stop
229-231					Left rotation speed 1 min.
232-234					Left rotation speed 2
235-237					Left rotation speed 3
238-240					Left rotation speed 4
241-243					Left rotation speed 5
244-246					Left rotation speed 6
247-249					Left rotation speed 7
250-252					Left rotation speed 8
253-255					Left rotation speed 9 max.

DMX CHANNEL	8	Parameter: MACRO CMY / COLOUR
-------------	----------	--------------------------------------

DMX range Value	Mid point DMX value	Move range (degrees)	Mode	Option	Function
0-19					No Function
20/255					Macro

DMX CHANNEL	9	Parameter: EFFECTS
-------------	----------	---------------------------

DMX range Value	Mid point DMX value	Move range (degrees)	Mode	Option	Function
0-19					No effect
20-39					Frost
40/255					Beam Shape

DMX CHANNEL	10	Parameter: ZOOM
-------------	-----------	------------------------

DMX range Value	Mid point DMX value	Move range (degrees)	Mode	Option	Function
0-225					Proportional