

DMX TOOLS

- DMuX
- Store
- Buffer
- (Rack- and Truss-Mounting)
- Merge

INSTALLATION AND OPERATING MANUAL

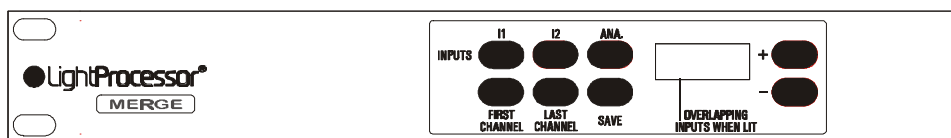
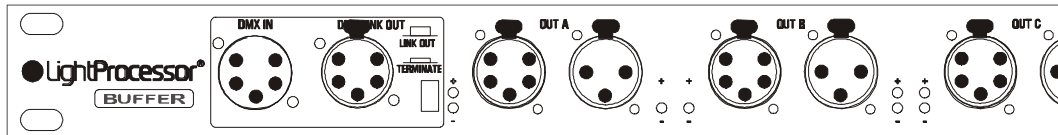
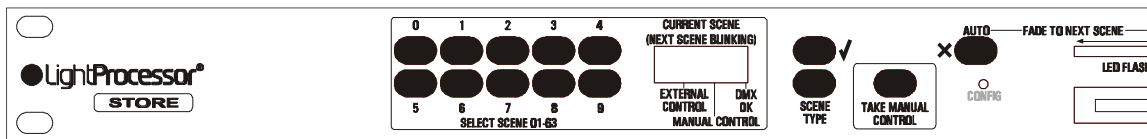
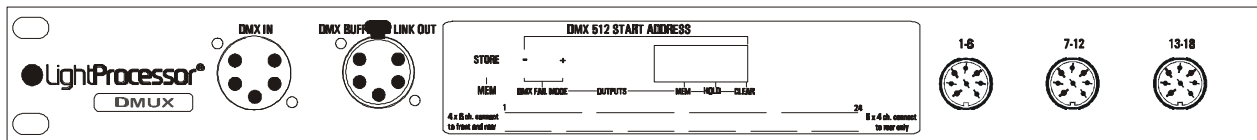

Thank you for buying a LightProcessor product. To obtain the best results, please read this instruction manual carefully.



Nous vous remercions d'avoir acheté un produit LightProcessor. Pour obtenir les meilleurs résultats, nous vous prions de bien vouloir lire attentivement ce manuel.



Wir bedanken uns für die Wahl eines LightProcessor-Produktes. Für eine reibungslose Bedienung lesen Sie sorgfältig dieses Handbuch.



Le damos las gracias que Ud. ha comprado un producto de LightProcessor. Para los mejores resultados lea cuidadosamente este manual.



Please be aware of the following warning notices and their meaning!
Veillez faire attention aux avertissements suivants!
Beachten Sie bitte die folgenden Warnungen !
Dese cuenta de los siguientes avisos importantes!



CAUTION! RISK OF ELECTRIC SHOCK
ATTENTION! RISQUE DE CHOC ELECTRIQUE
ACHTUNG! GEFAHR EINES STROMSCHLAGES
¡ATENCIÓN! PELIGRO DE SHOCK ELECTRICO



CAUTION! REFER TO INSTRUCTION MANUAL
ATTENTION! REFEREZ-VOUS AU MODE D'EMPLOI
ACHTUNG! BEACHTEN SIE BITTE DIE BEDIENUNGSANLEITUNG
¡ATENCIÓN! REFERIRSE AL MANUAL DE INSTRUCCIONES



IT IS ESSENTIAL THAT YOU MAKE AN EARTH CONNECTION BEFORE CONNECTING THE EQUIPMENT TO THE MAINS SUPPLY .
IL EST INDISPENSABLE DE RACCORDER L'APPAREIL A LA TERRE AVANT D'ETABLIR LA CONNECTION AU SECTEUR.
VOR ANSCHLUSS DES APPARATS BITTE UNBEDINGT EINE ERDUNG DURCHFÜHREN.
ALTA VOLTAJE. NECESITA ABSOLUTAMENTE UNA CONEXION CON TIERRA ANTES DE HACER LA CONEXION A LA RED.

The material contained in this document is for information purposes only and is subject to change without notice. LightProcessor Limited assumes no responsibility for any errors or omissions that may appear in this manual.

Le contenu de cette documentation n'est donné qu'à titre indicatif et peut changer sans avis préalable. LightProcessor Limited n'accepte pas de responsabilité pour n'importe quelle erreur ni omission.

Die Informationen in diesem Handbuch sind unverbindlich gegeben und wir behalten uns das Recht vor, Änderungen zu machen. LightProcessor Limited akzeptiert für Fehler und Auslassungen keine Verantwortlichkeit.

El contenido de este documento es dado para su información solamente y está sujeto a cambios sin previo aviso. LightProcessor Limited aceptan ninguna responsabilidad para errores y omisiones.

CONTENTS

	Page
DMuX	3
Store	5
Buffers	13
Merge	15

ACCESSORIES PACKED WITH THE PRODUCT

Instruction Manual - all products

GENERAL INSTRUCTIONS

Read the instructions in this handbook carefully, as they give important information regarding safety during installation and use.

Be sure to keep this manual with the product for ease of future reference. If the product is sold or given to another operator, make certain that they also receive the manual.

- This product is not intended for home use.
- After removing the packaging, check that the product is not damaged in any way. If in doubt, do not use it. Contact an authorised LightProcessor distributor.
- Packaging material (plastic bags, foam, nails etc.) must not be left within the reach of children, as it can be dangerous.
- The product must only be operated by adults. Do not allow children to tamper or play with it.
- The electrical work necessary for installing the product must be carried out by a qualified electrician.

NEVER USE THE PRODUCT UNDER THE FOLLOWING CONDITIONS:-

- In places subject to excessive humidity
- In places subject to vibrations or bumps
- In places with an ambient temperature in excess of 30°C or less than 0°C
- Protect the product from excessive dryness or humidity (ideal conditions are between 35% and 80%)
- Do not dismantle or modify the product
- Ensure that no liquids or metal objects enter the product
- Should any liquid be spilled on the product, disconnect the power supply immediately
- In the event of serious operating problems stop using the product immediately and either contact the nearest LightProcessor distributor for assistance or contact the manufacturer directly
- Never try to repair the product yourself. Repairs by unqualified people could cause damage or faulty operation. Contact your nearest LightProcessor dealer
- When carrying out any work, always comply (particularly regarding safety) with all regulations in force in the country in which the product is being used

ALWAYS INSIST ON ORIGINAL SPARE PARTS BEING FITTED

QUICK SET-UP AND INSTALL

1. Unpack the Product. (Ensure you do not throw away any accessories packed separately in the box.)
2. Mount the product in a 19 inch rack; it requires 1U of space. In the case of the Buffer secure it to the rig using a hook clamp and safety chain.
3. Connect control cables.
4. Make an earthed mains connection.

DMuX

The DMuX is a 24 channel demultiplexer which decodes DMX512 (1990 or earlier) signals and converts them into 0 to +10V analogue signals. A negative output model is available on special order

POWER CONNECTION

The DMuX requires no external power transformer and should be connected directly to a mains voltage as indicated on the unit's rear panel.

Applying mains to the DMuX in the absence of a DMX input signal will produce a fault condition, indicated by 'Flt' in the display.

DMX CONNECTION

Buffered DMX input and through connection to the DMuX may be made using either the 5-pin XLR on the front panel or the 3-pin XLR on the rear panel, as you choose. In all cases XLR's should be wired according to the USITT standard:- pin 1 screen, pin 2 data negative, pin 3 data positive. Pins 4 and 5 on the 5-pin XLR are not used.

ANALOGUE CONNECTION

Analogue output channels are as shown below. Whether you use the four 8-pin DIN's on the front or the rear panel, as shown in Fig. 1, or the six 5-pin DIN's on the rear, as shown in Fig. 2 is again a matter of choice. The analogue output voltage is 0 to +10V. 0 to -10V units are available to special order. Connectors are labelled to indicate which channels of the 24 they refer to.

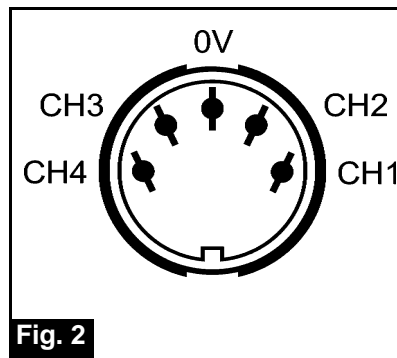
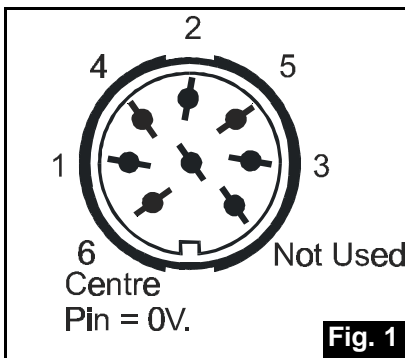

SETTING THE DMX START ADDRESS

The DMuX requires one start address which refers to a group of 24 consecutive DMX channels.

Use the buttons '+' and '-' to select the desired start address, then press 'STORE'. The letters 'ADD' will appear in the display to indicate that the address has been stored.

OUTPUT FROM THE DMuX

Output is indicated in the monitor LEDs.

DMuX

DMX FAIL MODES

When no DMX signal is received by the DMuX or some other fault condition exists, the letters 'Flt' will appear in the display.

You may pre-program one of the following options as a response, in case such a fault condition should occur. See Fig. 3:-

MEM A pre-programmed scene is output.

HOLD The last instruction received is held in the outputs.

CLR Nothing is output.

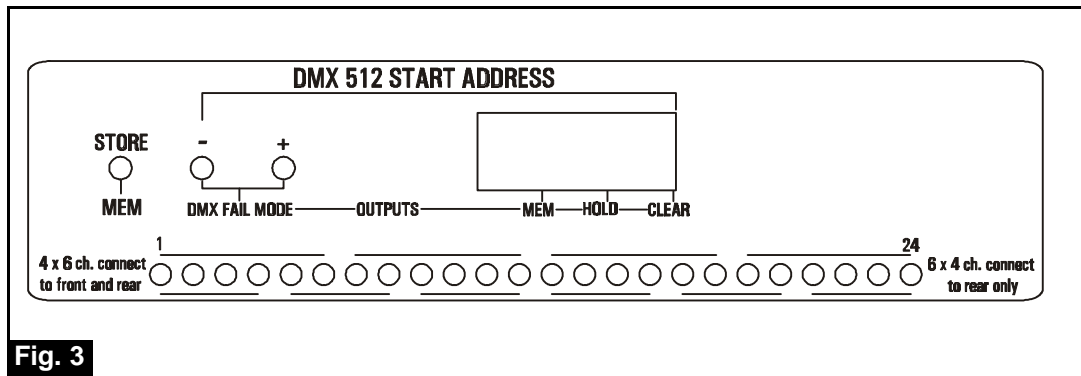

Fig. 3

The current mode is indicated by a dot in the bottom of one of the sections of the display. The mode is changed by holding down both the + and - buttons together; the dot then scrolls between the sections. When the dot appears in the appropriate section of the display, hold down STORE until SCE appears in the display. The mode is now selected and remains in memory until cancelled by re-programming.

To store a scene using the MEM function, first output the scene from your desk or controller. Hold down the + and - buttons until the dot appears in the MEM section of the display. Hold down STORE until the letters SCE appear in the display.

Store

GENERAL

The Store is designed to be rack mounted. The 5-pin XLR DMX connectors and the mains input are rear panel mounted. There is also a 25-pin sub-D connector on the rear panel for optional remote control.

USES

The Store is suitable for use as a back-up to any DMX lighting controller, storing up to 64 scenes of all 512 DMX channels. Install it as the first device in the DMX chain after the controller.

Alternatively, it can be used as a stand-alone playback unit, once it has been loaded from a controller or from a memory card.

OPERATING MODES

(a) Configuration Mode

(i) To set up global fade and hold times. These are the default times that will apply to any scene for which no specific time is programmed.

(ii) To tell the Store what to do in the event of a loss of data.

(b) Pass Through Mode

When DMX signals are being received and neither manual nor remote control is active, the Store remains passive and allows the DMX signal to pass down the chain to the next DMX device. Pass Through Mode is indicated in the display by a dot showing 'DMX OK'.

(c) Scene Loading

Scenes are loaded into memory while the Store is in Pass Through mode.

(d) Manual Control

The Store may be controlled manually from the front panel, either switching to the next scene by means of the AUTO button or fading to the next scene using the slider. During the fade the slider LED flashes to indicate that a fade is in progress. Manual Control active is indicated in the display by a dot showing 'MANUAL CONTROL'

(e) External Control

Alternatively the Store may be remotely controlled by +10/12V signals. The sub-D connector, mounted on the rear panel, is used for this purpose. Separate fade and hold times are assignable to individual scenes, along with flags designating a scene as the first or last in a sequence. The sequence may be set to run once or to loop. External Control active is indicated in the display by a dot showing 'EXTERNAL CONTROL'.

SWITCHING ON

THESE INSTRUCTIONS ASSUME THAT THE STORE IS CONNECTED TO A SOURCE OF DMX AND THAT IT IS RECEIVING A VALID SIGNAL. IF THE STORE IS NOT RECEIVING DMX, IT WILL ENTER MANUAL MODE AND WILL NOT ALLOW CONFIGURATION OR PROGRAMMING.

If the slider has been left parked in an active position, the display will show SLI and the slider LED will flash. Move the slider to its inactive zone, i.e. above 90% or below 10%.

When switched on for the first time the display will show a flashing ---. On subsequent occasions it will show the number of the first valid scene.

Store

CONFIGURATION

This mode allows the adjustment of (a) a global fade time, (b) the global hold time and (c) a loss of data key. Press SCENE TYPE at any time to toggle between (a), (b) and (c). Press ✕ to exit configuration mode. See Fig. 4. The Store must be receiving DMX. To enter configuration mode, press the CONFIG switch using a thin screwdriver or similar device. The display shows CnF.

GLOBAL FADE TIME

The display shows FAd, followed by the current global fade time expressed in seconds 0-99. Move the slider to adjust the fade value between 0-0.9 seconds and 1-99 seconds, then press ✓. The display then shows YES, then the new global fade time.

GLOBAL HOLD TIME

Press ✕ to exit configuration mode or SCENE TYPE to adjust the global hold time. The display shows Hld and then the current hold time. Move the slider to adjust the hold value between 0-0.9 seconds, 1-59 seconds and 1-30 minutes, then press ✓. The display then shows YES, then the new global hold time.

To avoid confusion when setting fade and hold times note the position of the dot in the display, as follows:-

00.1 = one tenth second.

01.0 = one second

1. = one minute

LOSS OF DATA KEY

Press ✕ to exit configuration mode or SCENE TYPE to adjust the loss of data code. The display shows Lod. There are four loss of data keys available. For stand-alone use select Lod 3; for backup use choose Lod 0,1 or 2.

0 = Blackout. Display shows --- on loss of data.

1 = Hold last valid signal received. Display shows --- on loss of data.

2 = Go to and hold scene 00. Display flashes 00 on loss of data.

3 = Hold the currently selected scene. Display shows scene number on loss of data.

Use the slider to adjust these values, then press ✓. The display shows YES, then the new value.

Press SCENE TYPE to return to fade time adjustment or ✕ to exit configuration mode.

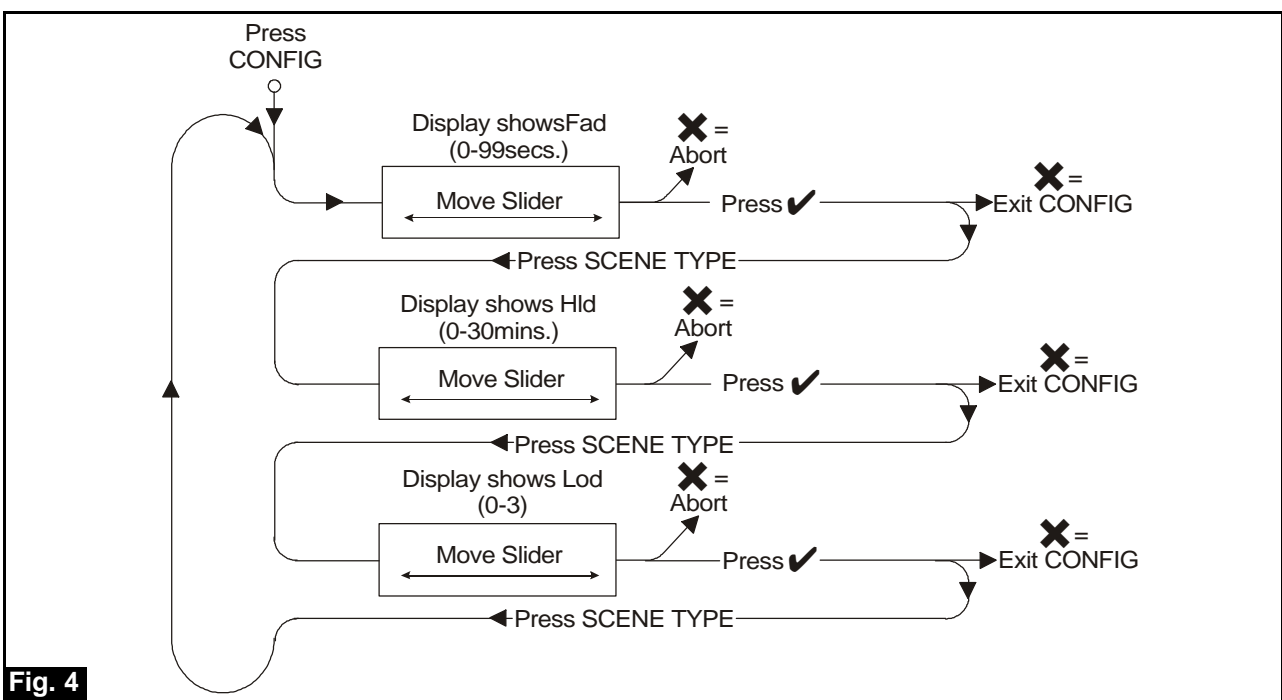

Fig. 4

Store

LOADING SCENES INTO THE STORE

Ensure that the Store is in Pass Through mode, i.e. release manual and/or external control.

Output the desired scene from any DMX desk or controller.

Give the scene a number between 00 and 63 using the numeric buttons.

Hold the ✓ button pressed. The display first shows Scn and then YES.

Release the ✓ button. The scene is now stored under the number you chose.

A number of attributes are stored with each scene. These are explained under the section, SCENE TYPES.

THE DEFAULT SCENE

As described in the section CONFIGURATION, it is possible to program the Store to go to a default scene when no DMX signal is received. This is scene 00. It may be loaded into memory in Pass Through mode just like any other scene. It may be selected in Pass Through mode and then output in Manual Mode or External Mode but it may not be accessed when in Manual Mode or External Mode.

SELECTING A SCENE

Use the numeric buttons to select a scene between 00 and 63. The number of the selected scene is shown in the display.

If you are in Pass Through mode, the chosen scene will be output when you go to Manual Control. If you are in Manual Control, the chosen scene will be the next scene to be output after pressing the AUTO button or using the slider. In External Control the chosen scene will be the next scene to be output after the use of the STEP command.

SCENE TYPES

When you set up a scene (see the section LOADING SCENES INTO THE STORE), it is given default fade and hold times according to the selections made during configuration.

While in Pass Through Mode use the SCENE TYPE button :-

- To change or edit fade and hold times.
- To reset the scene back to default values.
- To delete it.
- To flag it as the first scene in a sequence.
- To flag it as the last scene in a sequence.

Each press of the button will step you through the following list. Install the TYPE as indicated in the table. Abort any option by waiting for a time-out after five seconds or by pressing ✓.

FADE values are adjustable between 0-0.9 seconds and 1-99 seconds. HOLD is adjustable between 0-0.9 seconds, 1-59 seconds and 1-30 minutes.

The following table shows the available scene types.

Store

TYPE	FUNCTION	TO INSTALL TYPE
rST FAd	Sets default values Set FADE on and allow adjustment.	Press STORE until display shows YES Press STORE. Current FADE value is shown in display. Adjust value using slider. Press 4 until display shows YES to save.
HId	Set HOLD on and allow adjustment.	Press 4. Current HOLD value is shown in display. Adjust value using slider. Press 4 until display shows YES to save.
dEL SoC End	Delete scene Start of chase sequence Last scene in chase sequence	Press 4 until display shows YES Press 4 until display shows YES Press 4 until display shows YES

PASS THROUGH MODE

Pass Through mode active is indicated by a dot in the righthand element of the display, labelled DMX OK.

Valid DMX is being received and the Store is inactive.

MANUAL CONTROL

Manual control active is indicated by a dot in the centre element of the display.

If the DMX signal fails, the Store automatically enters MANUAL MODE and acts according to the LOSS OF DATA key programmed during configuration.

Alternatively, you may enter MANUAL CONTROL mode by pressing the TAKE CONTROL button. The Store then outputs the scene shown in the display until it receives a further command.

MOVING BETWEEN SCENES WITH THE AUTO BUTTON

If the AUTO button is pressed, the Store steps to the next valid scene. If any other scene is selected, the display will flash alternately the number of the current scene and the number of the next-selected scene. Press AUTO to step to the next-selected scene.

Any programmed fade time is processed; hold times are ignored. When the last programmed scene or scene 63 is accessed, the next step will be to scene 1.

MOVING BETWEEN SCENES WITH THE SLIDER

Move the slider and the Store fades from the current scene to the next valid scene at the speed that you move the slider. The display flashes alternately the number of the current scene and the next scene. The slider LED flashes to show that a fade is in progress when it is between 10% and 90% of its travel.

You may elect to fade to any valid scene. Enter the number of the scene to which you want to fade. The display flashes alternately the number of the current scene and the desired scene. During the fade the slider flashes to show that it is active.

Pre-programmed fade and hold times are ignored. When the last programmed scene or scene 63 is accessed, the next fade will be to scene 1.

Store

CHASE SEQUENCES

When a scene of the type SoC is encountered, a chase starts to run according to pre-programmed fade and hold times. It ignores any deleted or empty scenes and continues until it encounters a scene of the type End: it then loops back to the SoC scene. To stop a chase and pass to the next scene outside the loop, use the slider or press AUTO. During a chase the display shows only the number of the first scene in the chase. The slider LED flashes slowly to indicate that a chase is running.

RETURN TO PASS THROUGH MODE

Press TAKE MANUAL CONTROL to return to PASS THROUGH MODE, so long as DMX is being received (a dot is showing in the right hand element of the display).

If DMX is not being received, the Store remains in MANUAL MODE.

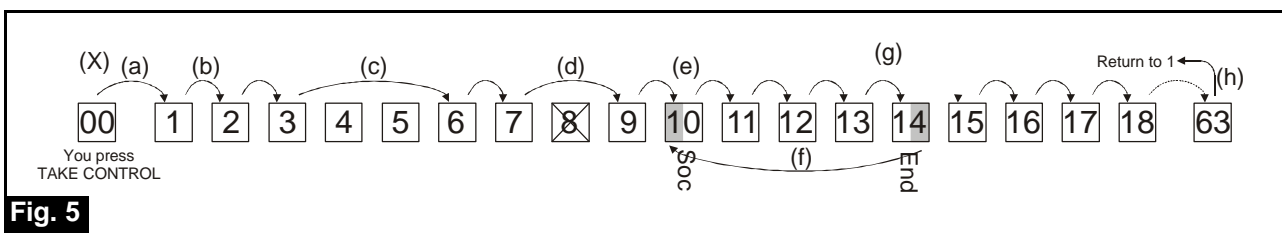

Fig. 5

MANUAL CONTROL - EXAMPLE

(x) The DMX input fails. The unit outputs scene 00 and switches to manual control.

(a) The first press of the AUTO button advances the Store to scene 1.

(b) Either -

Subsequent presses of AUTO advance you to scenes 2 and 3. FADE times are actioned but HOLD times are ignored.

Or -

Subsequent use of the slider advances you to scenes 2 and 3. Both FADE and HOLD times are ignored.

(c) Entering a new scene number in the display, e.g. scene 6 and then using the AUTO button or the slider advances you to that scene, dealing with FADE and HOLD times according to the rule given above in (b).

(d) Deleted or unprogrammed scenes are ignored. There is no effect on the outputs, nor on FADE and HOLD times.

(e) When a scene marked START OF CHASE is encountered, the unit steps automatically through the chase, using programmed FADE and HOLD times until...

(f) A scene marked END is encountered. At this point it loops back to the START OF CHASE scene. During a chase the display shows only the number of the START OF CHASE scene.

(g) If, during the running of a chase, you press AUTO or use the slider, you pass to the next valid scene after the END scene.

(h) When the last valid scene is reached or when scene 63 is reached, the next press of AUTO or use of the slider takes you to scene 1 or the first valid scene.

Store

EXTERNAL CONTROL

External control active is indicated by a dot in the left hand element of the display.

When you latch the external control line, there is no output from the Store and --- is shown in the display. Flash STEP to access the first valid scene.

Subsequent use of STEP will advance to the next valid scene or the selected scene shown in the display. Hold times are ignored but fade times are processed.

Latch or flash START to begin an automatic sequence that processes both fade and hold times.

Latching STOP ends a sequence after processing the current fade or hold command. The Store then awaits a STEP or START command.

Latching PAUSE suspends a sequence without completing the current command. When PAUSE is released, the sequence resumes from the pause point unless a new scene has been selected. In this latter case all of the relevant fade or hold time is processed.

Flashing TOP takes the Store back to the --- blackout state. If START is latched on, the sequence will begin to run. If TOP is latched on, the Store goes back to the --- blackout state and stays there until TOP is released.

Attempting to STEP beyond scene 63 takes you back to the --- blackout state and the Store waits for a new STEP or START command. If START was latched on already, the sequence loops automatically back to the first valid scene.

DELETED empty scenes are ignored.

An SoC scene causes a chase to start running according to the pre-programmed fade and hold times. When an End scene is encountered, the chase will loop and continue to run. To leave a chase loop and pass to the next valid scene, flash STEP. During a chase only the number of the SoC scene is shown in the display. The slider LED flashes slowly to indicate that a chase is running.

If an END scene is encountered outside a chase loop, any sequence is stopped after the current fade or hold time has been processed.

EXTERNAL CONTROL - EXAMPLE

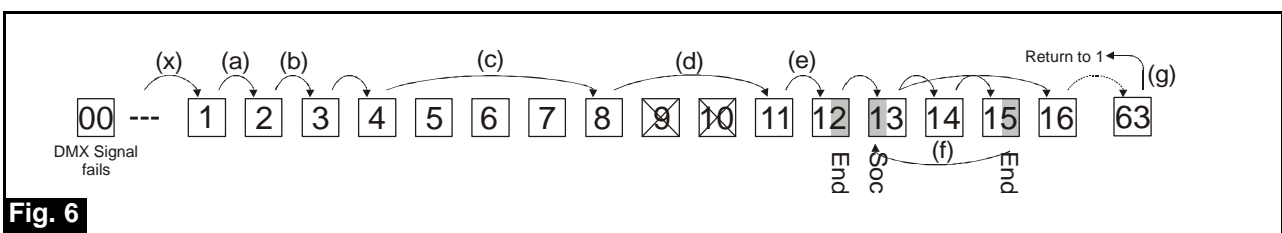

This example assumes that the loss of data key has been set to 2, i.e. scene 00 is output.

(x) The DMX input fails. You activate external control. There is no output from the Store until STEP is pressed.

(a) Either

Latch or flash START to begin a sequence (scenes 1, 2, 3, 4 etc.) which observes programmed fade and hold times.

Or

Press STEP to move to the next valid scene. Hold times are ignored but fade times are observed.

Store

(b) When STOP is pressed, the unit completes any fade or hold already in progress and then waits for a STEP or START command.

(c) Entering a new scene in the display via the address lines and pressing STEP will take you to that scene, observing any programmed FADE time. While that scene remains selected, further presses of STEP will have no effect. If the address lines are switched off, flashing STEP advances you to the next valid scene.

(d) Deleted or unprogrammed scenes are ignored.

(e) If an END scene is encountered (without a corresponding START OF CHASE), a running sequence stops according to (b) above.

(f) When a START OF CHASE scene is encountered, the chase runs automatically, observing programmed fade and hold times. On arriving at an END scene, the chase loops back to the START OF CHASE scene and continues to chase. The display shows the number of the START OF CHASE scene.

(g) When scene 63 is reached the sequence returns to the --- blackout state and awaits another STEP or START command. If START has been latched on, the sequence begins again automatically.

NOTE: If at any time PAUSE is switched on, any FADE is frozen. If PAUSE is released and the same scene is still valid, the fade continues from the point where it froze. If the scene number has changed, any associated FADE will start from the beginning.

REMOTE INPUT DEVICE

External control signals are input via the D-connector on the rear of the Store. A touch panel or any other device giving 10/12V signals is suitable as a remote input device. Note that a combination of latching and flashing switches is required. See Fig. 7.

Alternatively, the Store itself can provide the external control voltage. Wire appropriate switches into a circuit, as shown in Fig. 7.

PIN	FUNCTION	CODE
8-13	Address lines. Latch on to express scene number in binary. 13 is LSB.	ADR
7	Flash to step to selected scene.	STEP
6	Latch on to start sequence. Flash to advance to next scene.	START
5	Latch on to stop sequence.	STOP
4	Latch on to take external control.	EXT
3	Latch on to PAUSE a running sequence. Release to re-start.	PAUSE
2	Flash to go to first valid scene	TOP
1	Not used	
21-25	0V	
19-20	Not used	
14-18	+12V	

Store

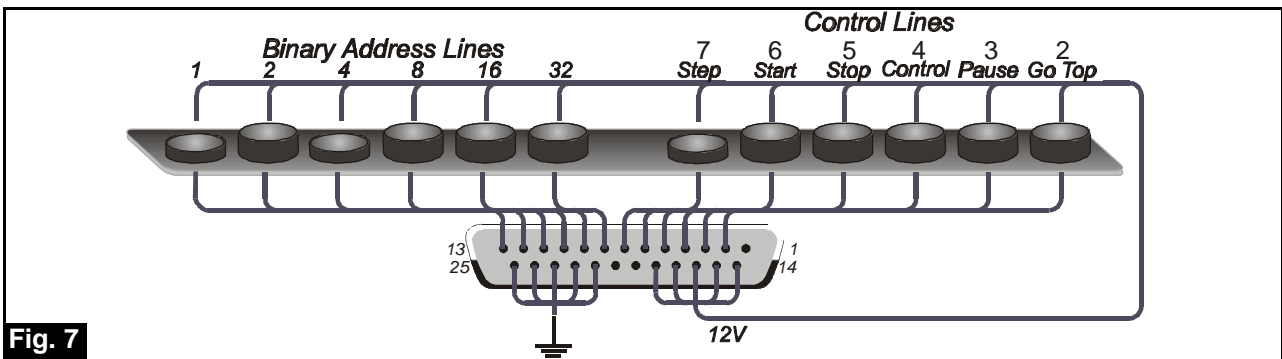

Note that linking pins 4 and 14 enables external control.

For stand-alone use and for automatic sequence starting it is sufficient to link pins 4 and 14 and pins 6 and 15.

MEMORY CARD

The memory card type is PCMCIA type 1, 256k (or greater) SRAM.

If the Store is in EXTERNAL CONTROL mode, the memory card is ignored. Otherwise, when the card is inserted, the display shows Crd.

To Store to Card

Hold pressed for two seconds. Sto appears in the display, followed by YES. If the card is write-protected, Pro is seen in the display. The card stores all scenes, scene types, fade times and hold times.

To Recall from Card

Hold AUTO pressed for two seconds. rcl appears in the display, followed by YES. If the card is write-protected, Pro is seen in the display. All scenes, scene types, fade times and hold times are loaded into the Store.

DMX CONNECTIONS

DMX connections to the QStore are via 5-pin XLR connectors, wired pin 1 = screen, pin 2 = data -, pin 3 = data +. Pins 4 and 5 are not used.

Buffer, Rack and Truss-mounting

The LightProcessor Rack- and Truss-Mounting Buffers are functionally identical.

Both products split, isolate, buffer and boost incoming DMX signals to four 1kV opto-isolated output channels. See Fig. 8. They are designed to protect against DMX line faults, incorrect connection and earth loops. Additionally they offer a means of Y-splitting a DMX signal and boosting DMX signals in very long cable runs.

Each output channel comprises one 5-pin XLR output and one 3-pin XLR connector. (Products with eight 5-pin XLRs or eight 3-pin XLRs are available to order). Since each of the output connectors is independently driven, all eight outputs may be used.

INSTALLATION

Verify the Buffer's operating voltage before mounting. The truss mounting version should be mounted to the truss/structure using a hook clamp attached to the M10 bolt on its top face. A suitable safety chain should be passed around the truss/structure and through the safety loop on the Buffer.

Before installing the rackmounting version set its operating voltage, using the rear panel voltage selector switch. The mains cable enters through the rear panel.

Both devices are supplied fitted with one metre of mains cable for connection to a suitable mains supply of 16A maximum.

The truss mounting version's input and through DMX connections are made to the left hand side. The outputs are on the bottom. For the rackmounting version all connections are made via the front panel.

The main DMX chain is connected via the 5-pin XLR input and through connectors, thus providing a signal input to the Buffer and a loop out to the next DMX device in the chain. If the Buffer is the last device in the DMX chain, the line should be terminated by pressing the DMX line termination switch.

Connect the devices to be protected to the output connectors. Note that up to eight devices may be connected but that only four channels of opto-isolation are provided.

OPERATION

The input and through connectors are linked when the unit is not powered. When the unit is powered up a relay switches a buffer in between the input and through connectors.

Each output channel is fitted with a red and a green LED. These LEDs mimic the activity of the data true and data invert DMX lines and flash rapidly during normal operation. Absence of this flashing in one LED indicates a fault on that line. No flashing of either LED probably indicates an absence of DMX.

Buffer, Rack and Truss-mounting

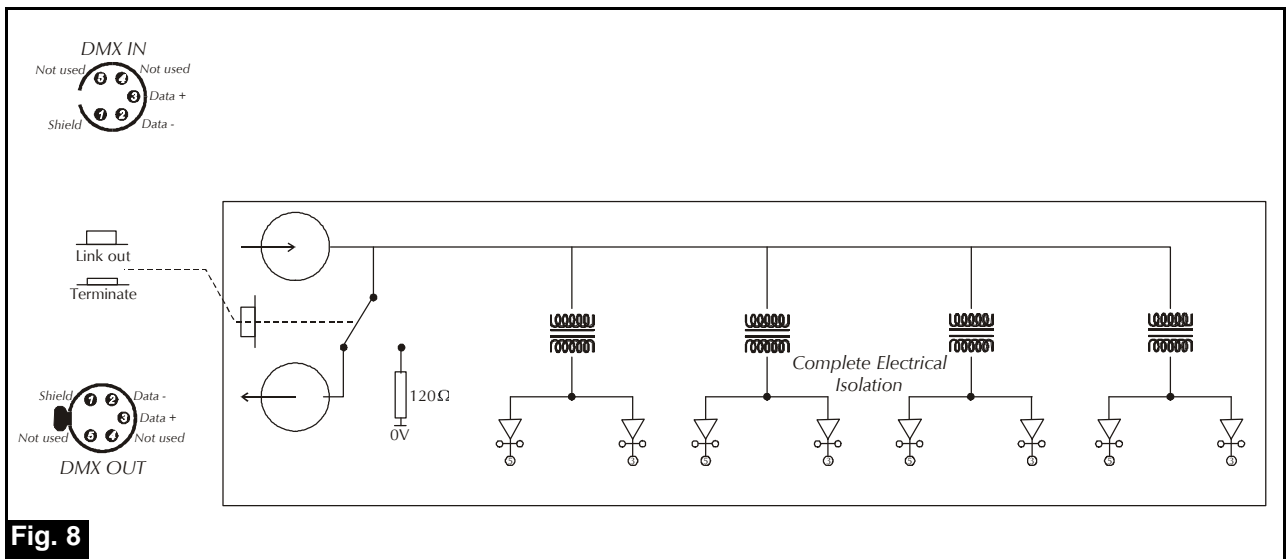

Fig. 8

Merge

The Merge takes two DMX data stream inputs and combines them into a single DMX output data stream.

Additionally, a 24-channel analogue data stream may be input, multiplexed and merged with the master DMX output.

Where there are multiple inputs to a single output channel, it is the highest level signal received that is output (HTP).

Inputs may be offset, one from another, to begin at any point in the output stream. Inputs may also be truncated, so that only a selected number of channels is added to the output.

The input DMX signal lines are opto-isolated to provide a high degree of isolation between data paths.

OPERATING VOLTAGE

The Merge is designed to operate on 230V AC. A 115V version is available to order.

MOUNTING

The Merge mounts in a standard 19 inch rack. It is one rack unit high.

HARDWARE CONNECTIONS

All connections are made via the rear panel.

MAINS INPUT

Fit an appropriate mains plug and connect to the mains. In the UK the plug should be fitted with a 3Amp fuse.

CONTROL INPUTS

DMX input is via two XLR5 male connectors, wired according to the USITT(1990) protocol.

Analogue input is 0 to +10V via a 25-pin sub-D (male) connector. Channel connection details are shown in Fig. 9 below.

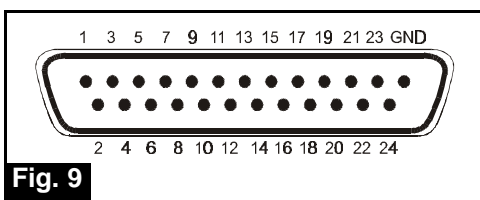

DMX OUTPUT

The DMX output is via an XLR5 female connector, wired according to the USITT(1990) protocol.

OPERATION

When power is applied to the Merge, the letters 'run' will appear in the display.

If no offsets are programmed, the second DMX input stream is superimposed directly on the first and output will occur according to the highest takes precedence rule, i.e. the highest of the two DMX input levels and the analogue input will be output.

Merge

OFFSETS

The setting of offsets may best be illustrated by using an example, as described below and shown in Fig. 10.

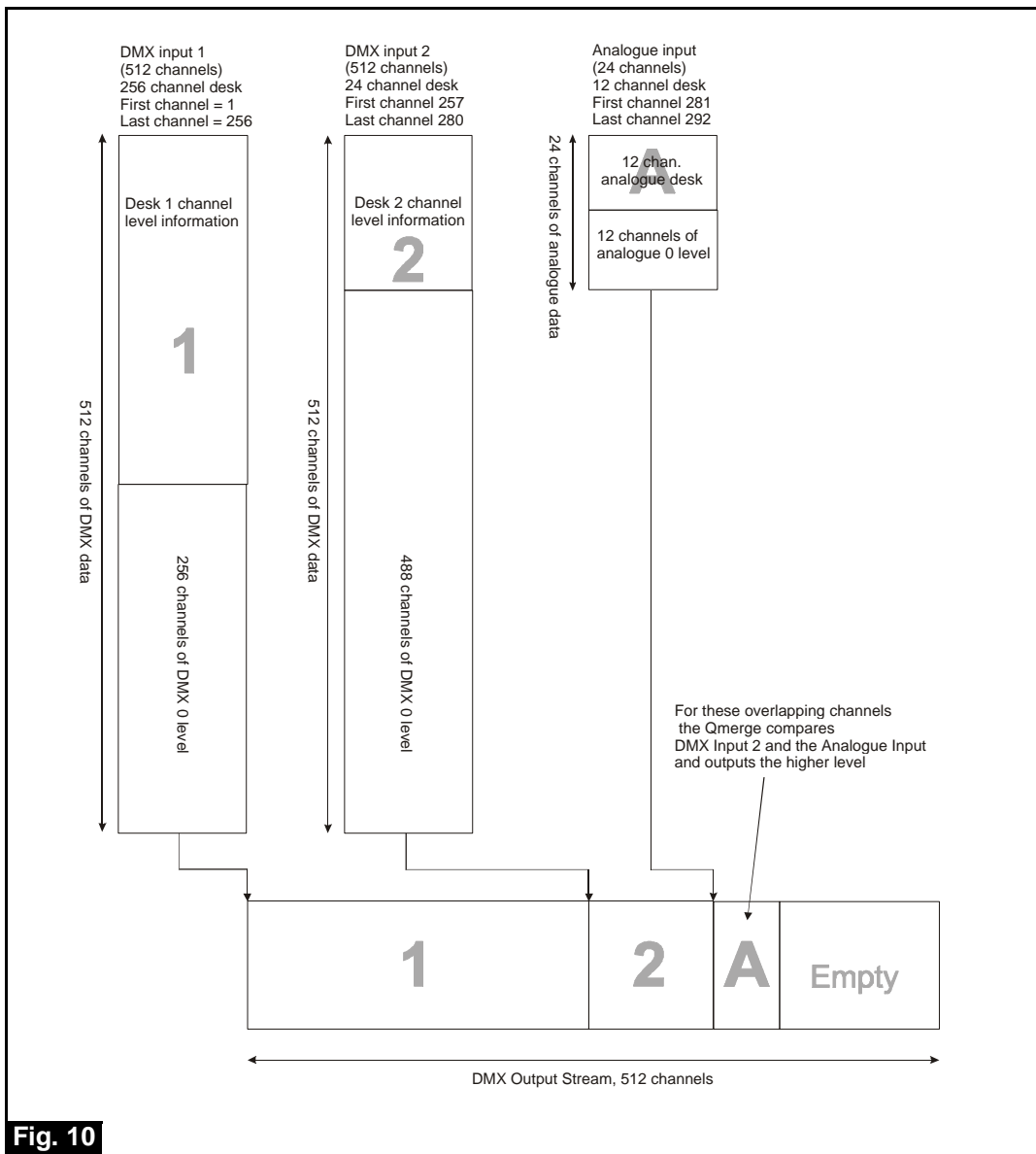

Fig. 10

Assume that you wish to merge the outputs from

- (a) a 256-channel DMX desk (Input 1)
- (b) a 24-channel DMX desk (Input 2)
- (c) a 12-channel analogue desk (Analogue)

To clear any previous programming of offsets, select the input you wish to clear by pressing either In1, In2 or Ana and then hold down + and - together until CLR appears in the display.

Merge

EXAMPLE

Input 1

Object

By default there is no offset and input 1 may be taken as the reference point beginning at channel 1 of the output stream. Channel 1 is therefore the FIRST CHANNEL. Since the desk used in the example only has 256 channels, it can be assumed that channels 257 to 512 of the 512-channel DMX signal will all be at level 0. Such information has no value, so we can set channel 256 as LAST CHANNEL .

Method

Display shows 'run'.

Press button I1. Display shows 'in1'.

Press FIRST CHAN. Display shows '001'. If it shows any other channel no., use the ± buttons to select channel '001'.

Press SAVE.

Press LAST CHAN. Display shows '512'.

Press '±' to change the channel number until '256' is displayed.

Press SAVE. Display shows 'Sto' and then reverts to 'run'.

Input 2

Object

We want the output from our 24-channel DMX desk to follow on after the 256-channel controller. We therefore need to program an offset to begin output at channel 257. Since the desk gives 24 channels of meaningful output (and the rest of the 512 channels of the DMX signal will be output as 0), we can truncate the output to 24 channels.

Method

Display shows 'run'.

Press button I2. Display shows 'in2'.

Press FIRST CHAN. Display shows '001'.

Press '±' to change the channel number until '257' is displayed.

Press SAVE.

Press LAST CHAN. Display shows '512'.

Press '±' to change the channel number until '280' is displayed.

Press SAVE. Display shows 'Sto' and then reverts to 'run'.

Analogue

Object

We want the output from the 12-channel analogue desk to follow on after the 24-channel DMX desk. We therefore need to program an offset to begin output at channel 281 and finish at 292.

Method

Display shows 'run'.

Press button Ana. Display shows 'AnA'.

Press FIRST CHAN. Display shows '001'.

Press '±' to change the channel number until '281' is displayed.

Press SAVE.

Press LAST CHAN. Display shows '24'.

Press '±' to change the channel number until '292' is displayed.

Press SAVE. Display shows 'Sto' and then reverts to 'run'.

NOTE: The analogue FIRST CHANNEL and LAST CHANNEL must be no more than 24 channels apart; any channels greater than analogue FIRST CHANNEL + 24 will contain unpredictable data.

SPECIFICATIONS

DMuX

Power Supply:	230V AC 50-60Hz (115V AC 50-60Hz version available on request)
Signal Input:	USITT DMX512 (1990)
Input Socket (Front)	DMX512 via 5-pin XLR
Input Socket (Rear)	DMX512 via 3-pin XLR
Link through (Front)	DMX512 via 5-pin XLR
Link through (Rear)	DMX512 via 3-pin XLR
Signal Output	+10V DC analogue (-10V version available) 10mA per channel
Output Sockets (Front)	4 x 8-pin locking DIN socket (female)
Output Sockets (Rear)	6 x 5-pin DIN socket (female) and 4 x 8-pin locking DIN socket (female)
Dimensions	1U (44mm) x 19" (482mm) x 165 mm
Weight	3.5Kg

Store

Power Supply	230V AC 50-60Hz (115V AC 50-60Hz version available on request)
Lighting Channels	512
Control Channels	6-Binary address, 6-Control functions
Signal Input (Lighting)	USITT DMX512 via 5-pin XLR
Signal Input (Control)	0-10V DC via 25 pin sub-D connector
Signal Output (Lighting)	USITT DMX512 via 5-pin XLR
Signal Output (Control)	Nominal 12V DC @ 30mA max
Memory	64 scenes of 512 channels. Memory may be saved to PCMCIA card.
Dimensions	1U (44mm) x 19" (482mm) x 165 mm
Weight	3.5Kg

Buffer

Power Supply	115/230V AC 50-60Hz (selectable)
Signal Input	USITT DMX512 via 5-pin XLR
Isolated Outputs	4 x 3-pin XLR and 4 x 5-pin XLR (all 5-pin version available on request)
Dimensions	QBuffer - 338mm x 191mm x 59mm. DMX Distributor - 1U (44mm) x 19" (482mm) x 200 mm
Weight	QBuffer - 4kg DMX Distributor - 3.8Kg.
Fixing	QBuffer - M10 bolt or optional wall mounting bracket DMX Distributor - Rack mount

Merge

Power Requirements	230V AC 50-60Hz (115V AC 50-60Hz version available on request)
Signal Inputs	USITT DMX512 (1990), via 5-pin XLR. 0 to +1 0V analogue via 25-pin sub-D connector.
Signal Output	USITT DMX512 (1990), via opto-isolated 5-pin XLR.
Dimensions	1U (44mm) x 19" (482mm) x 208 mm
Weight	3.6kg

Environmental - All Products

Temperature	0-30°C
Relative humidity	0-90% non-condensing
Pollution	Degree 2
Protection Classification	IP30
Conformance	Designed to meet CE regulations covered by: LVD (EN60950) EMC (BSEN50081-1 and BSEN50082-1)

SPARE PARTS

PRODUCT	ITEM	REFERENCE
DMuX	Fuse, electronics Transformer	F0.25MA2AS T30VATRX
Store	Switch, front panel Switch Cap Memory Card Slider, 20K, linear	SM12SWITCH CCD4GREY PCMCIA/512 P20KLINSLI
Buffer	Fuse, electronics Opto Isolator Transformer	F200MA2AS 6N137 T9V3VATRX
Merge	Switch, front panel Switch cap Transformer	924-933 925-019 T6VA/9-0-9

WARRANTY STATEMENT

LightProcessor provides a warranty against manufacturing defects for all Products for a period of eighteen months from date of shipping to the Customer provided that the Products have not been subjected to any unauthorised modification or repair.

LightProcessor shall not be liable to the Customer by reason of any representation or any implied warranty, condition or other term or any duty at common law for any indirect, special or consequential loss or damage, costs, expenses, or other claims for compensation whatsoever which arise out of or in connection with the sale or supply of the Products or their use or resale by the Customer.

All items added to the Product by the Customer, its agents or customers, must be removed from the Product prior to return to LightProcessor. The return of the Product shall authorise LightProcessor to remove any such items. LightProcessor shall not be obliged to reconnect any such items before returning the Product. LightProcessor will not be under any liability in respect of such items.

The liability of LightProcessor to its Customers for death or personal injury resulting from our negligence is unlimited. Apart from that, LightProcessor will not in any event be liable to its Customers for indirect or consequential loss, and any liability on behalf of LightProcessor for any loss or expense shall be limited to the contract price of the defective goods.

The cost of shipping defective Product back to LightProcessor is borne by the Customer. The cost of shipping back to the Customer is borne by LightProcessor.

LightProcessor reserves the right either to repair or replace any defective Product

WARRANTY REPAIRS PROCEDURE

Prior to any Product being shipped for warranty repair or replacement the Customer must have applied for a "Warranty Authorisation Number". These can be obtained from the Sales Administration Manager at LightProcessor's Head Office.

LightProcessor will then issue a 'Warranty Fault Report' that must be completed in all respects by the Customer. Failure to complete the 'Warranty Fault Report' may cause delays in processing the repair of the Product.

The completed 'Warranty Fault Report' may either be Faxed, E-Mailed, Mailed or accompany the Product when it is returned

LightProcessor will advise the Customer within 1 working day of the receipt of the Product or the Warranty Fault Report, whichever is the later, whether or not it accepts that the Product is covered under Warranty.

Warranty Repairs will be completed within 2 working days, subject to spare parts being available, and will be returned to the Customer without delay.

Should a Product be returned for repair in damaged packaging or other than its original, LightProcessor reserves the right to re-package the Product in its correct packaging and to charge £20.

NON-WARRANTY REPAIRS PROCEDURE

Prior to any Product being shipped for repair the Customer must have applied for a "Repair Authorisation Number". These can be obtained from the Sales Administration Manager at LightProcessor's Head Office.

LightProcessor will then issue a 'Repair Fault Report' that must be completed in all respects by the Customer. Failure to complete the 'Repair Fault Report' may cause delays in processing the repair of the Product.

The completed 'Repair Fault Report' may either be Faxed, E-Mailed, Mailed or accompany the Product when it is returned

LightProcessor will advise the Customer within 5 working days of the receipt of the Product or the Repair Fault Report, whichever is the later, the Estimated Cost of Repair excluding labour and carriage.

Non-Warranty Repairs will be completed within 10 working days of receipt by the Customer of the Repair Cost Estimate, subject to spare parts being available, and will be returned to the Customer without delay.

Should a Product be returned for repair in damaged packaging or other than its original, LightProcessor reserves the right to re-package the Product in its correct packaging and to charge £20.

QCommander 256 (standard and extended models)
QCommander 512 (standard and extended models)

Replica memory store and playback unit

- Paradime digital dimmer range

- Analogue and DMX 2-preset desks
Q12

- Analogue and DMX 1-preset desks
Zip 6

Zip 18

ILLUMINATING TECHNOLOGY
www.lightprocessor.co.uk
info@lightprocessor.co.uk

Note the serial numbers of the products in this installation and quote them when seeking help.